

BAE Systems
P.O. Box 509008
San Diego CA 92150-9008 USA
(858) 675-2600

Document No: 5034289
CAGE Code: 12346
Date: 23 October 2012

Mensuration Services Program (MSP) User's Guide for MSP Geographic Translator (GEOTRANS) Version 3.3

Program Title: Mensuration Services Program
Contract No: HM1572-10-D-0002/0008
CDRL: A017
DID: Contractor Format

Prepared For: National Geospatial-Intelligence Agency
7500 GEOINT Drive
Springfield, VA 22150

Change Log

Version	Date	Description of Change
01	3 December 2009	Original issue.
02	22 September 2010	Updated for release MSP GeoTrans 3.1. Includes minor corrections and new support for the EGM84 30 minute interval geoid separation grid.
03	6 October 2011	Updated for release MSP GeoTrans 3.2. Includes support for EGM 2008 and iterative geocentric to geodetic conversion.
04	12 January 2011	Update for EGM 2008.
05	23 October 2012	Updated for release MSP GeoTrans 3.3. Includes minor corrections.

Table of Contents

1. Introduction.....	1
1.1 Reference Documents	2
2. Getting Started	3
2.1 INSTALLING GEOTRANS.....	3
2.1.1 System ReQUIREMENTS.....	3
2.1.2 UNIX Installation Procedure.....	3
2.1.3 Windows Installation Procedure.....	4
2.2 Starting GEOTRANS.....	5
2.2.1 Required Data Files.....	5
2.3 Basic Operation.....	6
2.4 Exiting GEOTRANS	10
3. Coordinate Conversion & Datum Transformation.....	11
3.1 Datum Transformations	11
3.2 Coordinate Reference Frames.....	13
3.2.1 Coordinate Reference Frame Selection.....	15
3.2.2 Parameter/Coordinate Field Entry.....	15
3.2.3 Coordinate Conversion	42
3.2.4 Error Detection and Reporting.....	42
3.3 Options.....	42
3.3.1 Geodetic Units	43
3.3.2 Geodetic Separator.....	43
3.3.3 Sign/Hemisphere.....	43
3.3.4 Longitude Range.....	44
3.3.5 Precision.....	44
3.3.6 Leading Zeros.....	45

3.4 User-Defined Datums and Ellipsoids.....	45
3.4.1 Create Datum	45
3.4.2 Delete Datum	47
3.4.3 Create Ellipsoid.....	48
3.4.4 Delete Ellipsoid.....	48
4. File Processing.....	49
4.1 Basic File Processing.....	49
4.2 File Processing Details.....	53
4.2.1 Input File Selection.....	53
4.2.2 Output File Content Specification	54
4.2.3 Output File Saving.....	55
4.2.4 File Processing.....	55
4.2.5 Error Detection and Reporting.....	56
4.2.6 Input File Header Generation.....	57
4.3 GEOTRANS Coordinate File Format.....	57
4.3.1 Coordinate File Header.....	58
4.3.2 Coordinate File Body.....	65
4.3.3 Comments and Blank Lines	65
4.3.4 Output Files.....	66
5. Reference	67
5.1 Windows & Dialog Boxes	67
5.1.1 Main Window	67
5.1.2 File Processing Windows & Dialog Boxes.....	70
5.1.3 Create Ellipsoid & Create Datum Dialog Boxes	75
5.2 Menus, Fields, & Controls.....	79
5.2.1 Menu Bar	80

5.2.2	Fields and Controls	88
5.3	Error Conditions.....	102
5.3.1	Initialization Error Messages	102
5.3.2	Coordinate Conversion Error Messages	103
5.3.3	User-Defined Datum & Ellipsoid Error Messages.....	107
5.3.4	File Processing Error Messages	109
5.4	On-Line Help	112
6.	Notes	113
6.1	Glossary	113
6.2	Bibliography.....	116
A.	Coordinate Reference Frames, Datums & Ellipsoids	117
A.1	Coordinate Reference Frames	117
A.1.1	Geocentric Coordinates.....	118
A.1.2	Local Cartesian Coordinates	118
A.1.3	Geodetic Coordinates.....	120
A.1.4	GEOREF Coordinates.....	120
A.1.5	GARS Coordinates.....	123
A.1.6	Mercator Projection.....	124
A.1.7	Transverse Mercator Projection	125
A.1.8	Universal Transverse Mercator (UTM) Projection	125
A.1.9	Polar Stereographic Projection.....	126
A.1.10	Universal Polar Stereographic (UPS) Coordinates	127
A.1.11	MGRS Coordinates	128
A.1.12	Albers Equal Area Conic Projection	133
A.1.13	Azimuthal Equidistant Projection	134
A.1.14	Bonne Projection.....	135

A.1.15 British National Grid Coordinates	136
A.1.16 Cassini Projection	138
A.1.17 Cylindrical Equal Area Projection	139
A.1.18 Eckert IV Projection.....	139
A.1.19 Eckert VI Projection.....	140
A.1.20 Equidistant Cylindrical Projection	141
A.1.21 Gnomonic Projection	142
A.1.22 Lambert Conformal Conic Projection	143
A.1.23 Miller Cylindrical Projection	145
A.1.24 Mollweide Projection.....	146
A.1.25 New Zealand Map Grid Projection	147
A.1.26 Ney's (Modified Lambert Conformal Conic) Projection.....	148
A.1.27 Oblique Mercator Projection.....	149
A.1.28 Orthographic Projection.....	151
A.1.29 Polyconic Projection	154
A.1.30 Sinusoidal Projection	155
A.1.31 Stereographic Projection	155
A.1.32 Transverse Cylindrical Equal Area Projection.....	157
A.1.33 Van der Grinten Projection	158
A.1.34 F-16 Grid Reference System Coordinates.....	159
A.2 Datums & Ellipsoids.....	159
Appendix B – ACRONYMS	170

List of Figures and Tables

Figure 2-1. GEOTRANS Main Window	7
Figure 3-1. Create Datum Dialog Box	46
Figure 3-2. Delete Datum Dialog Box	47
Figure 3-3. Create Ellipsoid Dialog Box	48
Figure 3-4. Delete Ellipsoid Dialog Box	48
Figure 4-1. File Open Dialog Box (Windows)	50
Figure 4-2. GEOTRANS File Processing Window	50
Figure 4-3. Save As Dialog Box (Windows)	51
Figure 4-4. GEOTRANS File Processing Dialog Box	51
Figure 5-1. GEOTRANS Main Window	68
Figure 5-2. File Open Dialog Box (Windows)	71
Figure 5-3. GEOTRANS File Processing Window	72
Figure 5-4. GEOTRANS File Processing Dialog Box	74
Figure 5-5. Create File Header Window	75
Figure 5-6. Create Datum Dialog Box	77
Figure 5-7. Delete Datum Dialog Box	78
Figure 5-8. Create Ellipsoid Dialog Box	79
Figure 5-9. Delete Ellipsoid Dialog Box	79
Figure A-1. Relationship Between Geocentric and Geodetic Coordinates	119
Figure A-2. GEOREF 15° Quadrangles	121
Figure A-3. GEOREF 1° Cells within a 15° Quadrangle	122
Figure A-4. GARS	123
Figure A-5. Mercator Projection	124
Figure A-6. Transverse Mercator Projection	125

Figure A-7. Meridians and Parallels in the Polar Stereographic Projection (Left: South Zone, Right: North Zone. Not drawn to scale.).....127

Figure A-8. Meridians and Parallels on a UPS Grid (North zone)128

Figure A-9. MGRS Zones and Bands129

Figure A-10. MGRS 100,000m Square Designations (AL Pattern)130

Figure A-11. MGRS 100,000m Square Designations (AA Pattern).....131

Figure A-12. MGRS 100,000m Square Designations for North Polar Zone.....132

Figure A-13. MGRS 100,000m Square Designations for South Polar Zone.....133

Figure A-14. Albers Equal Area Conic Projection (Origin Latitude = 45°N, Standard Parallels = 40°N & 50°N).....134

Figure A-15. Azimuthal Equidistant Projection135

Figure A-16. Bonne Projection (Origin Latitude = 45°N).....136

Figure A-17. British National Grid137

Figure A-18. Cassini Projection.....138

Figure A-19. Cylindrical Equal Area Projection.....139

Figure A-20. Eckert IV Projection.....140

Figure A-21. Eckert VI Projection.....141

Figure A-22. Equidistant Cylindrical Projection142

Figure A-23. Gnomonic Projection.....143

Figure A-24. Lambert Conformal Conic Projection144

Figure A-25. Miller Cylindrical Projection.....145

Figure A-26. Mollweide Projection146

Figure A-27. New Zealand Map Grid Projection.....147

Figure A-28. Ney’s (Modified Lambert Conformal Conic) Projection (Origin Latitude = 80°N, Standard Parallels = 71°N & 89 59 58.0°N).....148

Figure A-29. Oblique Mercator Projection (Origin Latitude = 45°N, Latitude 1 = 40°N, Latitude 2 = 50°N, Longitude 1 & 2 = 0°)150

Document No. 5034289

Date: 23 October 2012

Figure A-30a. Orthographic Projection (Equatorial Aspect).....	151
Figure A-30b. Orthographic Projection (North Polar Aspect).....	152
Figure A-30c. Orthographic Projection (Oblique Aspect).....	153
Figure A-31. Polyconic Projection.....	154
Figure A-32. Sinusoidal Projection.....	155
Figure A-33. Stereographic Projection	156
Figure A-34. Transverse Cylindrical Equal Area Projection	157
Figure A-35. Van der Grinten Projection.....	158
Table A-1. Datums by Country/Geographic Area.....	160
Table A-2. Reference Ellipsoids and their Parameters	168

1. INTRODUCTION

This document is the User's Guide for Version 3.3 of the MSP Geographic Translator (GEOTRANS).

GEOTRANS (Geographic Translator) is an application that allows you to convert geographic coordinates among a wide variety of coordinate systems, map projections, grids, and datums. GEOTRANS runs in the Microsoft Windows, LINUX, and UNIX environments.

The user interface of GEOTRANS consists primarily of a single window. To convert coordinates, select the coordinate reference frame and datum in which your coordinates are defined, enter any associated parameters, and enter the coordinates in the upper half of the window. Then select the coordinate reference frame and datum to which you want the coordinates to be converted, and enter any associated parameters, in the lower half of the window. Click on the Convert: Upper-to-Lower button and the resulting coordinates will be displayed in the lower half of the window. You can convert additional coordinate sets from the same source by just entering the new coordinates and clicking on the Convert: Upper-to-Lower button. You can change the coordinate reference frame, datum, or parameter selections at any time. Also, you can reverse the roles of input and output by using the Convert: Lower-to-Upper button. Currently, thirty-five different types of coordinate systems, map projections, grids, and coding schemes are supported, as well as more than two hundred different horizontal datums.

GEOTRANS can also be used to efficiently convert large numbers of coordinates contained in text files. The file format is very simple. A multi-line file header defines the coordinate reference frame and datum of the coordinates contained in the file, including any associated parameter values. Following the header, each line contains a single set of coordinates, separated by commas. Using the GEOTRANS file processing interface, you can select an existing file of coordinates to be converted. You can then define the coordinate reference frame and datum to which you want to convert the coordinates, along with any associated parameter values. Finally, you can specify the name and location of the output file that is to be created. GEOTRANS then converts all of the coordinates in the input file and creates the output file as a single operation.

This manual describes how to use GEOTRANS to convert coordinates both interactively and via file processing. Section 2, Getting Started, describes how to start the GEOTRANS application, perform basic interactive coordinate conversions, and exit the application. Section 3 covers interactive coordinate conversion and datum transformation in more detail. Section 4 describes how to use GEOTRANS file processing capabilities. Section 5 contains reference information, describing all of the windows, controls, menu items, and fields that make up the GEOTRANS

user interface, as well as error conditions, and how to access the on-line help subsystem. Section 6 contains a glossary and bibliography. Appendix A contains brief descriptions of each of the coordinate systems, map projections, grids, datums, and ellipsoids supported by GEOTRANS.

1.1 REFERENCE DOCUMENTS

The following documents describe coordinate systems, map projections, coordinate conversion, and datum transformation:

1. NGA TM 8358.1, **Datums, Ellipsoids, Grids, and Grid Reference Systems**, 1990.
2. NGA TM 8358.2, **The Universal Grids: Universal Transverse Mercator (UTM) and Universal Polar Stereographic (UPS)**, 1989.
3. MIL-STD-2401, **Department of Defense World Geodetic System (WGS)**, 1994.
4. STANAG 2211, **Geodetic Datums, ellipsoids, grids and grid references**, Fifth Edition, 1991.
5. TEC-SR-7, **Handbook for Transformation of Datums, Projections, Grids and Common Coordinate Systems**, 1996.
6. NGA, **Department of Defense Glossary of Mapping, Charting, and Geodetic Terms**, Fourth Edition, 1981.
7. Rapp, Richard H., **Geometric Geodesy - Part I; Department of Geodetic Science and Surveying**, The Ohio State University, Columbus, Ohio, 1984.
8. Rapp, Richard H., **Geometric Geodesy - Part II; Department of Geodetic Science and Surveying**, The Ohio State University, Columbus, Ohio, 1987.
9. Snyder, J. P., **Geological Survey Professional Paper 1395 Map Projections – A Working Manual**, 1987.
10. Federal Geographic Data Committee (FGDC), FGDC-STD-011-2001, **United States National Grid**, December 2001
11. <http://earth-info.nga.mil/GandG/coordsys/grids/gars.html>, **Global Area Reference System (GARS)**
12. **ISO/IEC 18026:2006 Information Technology – Spatial Reference Model (SRM)**

2. GETTING STARTED

This section describes how to install the GEOTRANS software, start up the GEOTRANS application, perform basic coordinate conversions, and exit the application.

2.1 INSTALLING GEOTRANS

2.1.1 SYSTEM REQUIREMENTS

The hardware requirements of the GEOTRANS software are minimal. It is designed to run on any 32-bit or 64-bit processor with 512MB or more of memory and 300MB or more of available disk space.

GEOTRANS software operates on Solaris, Windows, and Red Hat Linux operating systems.

Platform	OS and Version	Compiler and Version
Sun	Solaris 10 SPARC 32-bit multi-thread	Sun Studio 12 C++ 5.10
PC	Red Hat Enterprise Linux 5 32-bit multi-thread	GCC 4.1.2
PC	Red Hat Enterprise Linux 5 64-bit multi-thread	GCC 4.1.2
PC	Windows XP SP2 32-bit multi-thread	Visual Studio 2008
PC	Windows 7 64-bit multi-thread	Visual Studio 2010

Table 1 – Supported Operating Systems and Compilers

2.1.2 UNIX INSTALLATION PROCEDURE

The distribution of GEOTRANS for UNIX downloaded from the website is packaged as a compressed tar archive named either `unix_user.tgz` or `unix_dev.tgz`. To install it:

1. Create a directory to contain the distribution:

```
% mkdir /home/geotrans
```

You may replace `/home/geotrans` with whatever path you choose.

2. Change your working directory to the directory you just created:

```
% cd /home/geotrans
```

Document No. 5034289

Date: 23 October 2012

3. Copy the archive from wherever it is located to the GEOTRANS home directory:

```
% cp unix_user.tgz /home/geotrans
```

4. Uncompress the archive using the Gnu unzip utility:

```
% gunzip unix_user.tgz
```

```
% tar xvf unix_user.tar
```

2.1.3 WINDOWS INSTALLATION PROCEDURE

The distribution of GEOTRANS for Windows downloaded from the website is packaged as a ZIP archive named either win_user.zip or win_dev.zip. To install it (using DOS commands):

1. Create a directory to contain the distribution:

```
C:\>mkdir \GEOTRANS
```

2. Change your working directory to the directory you just created:

```
C:\>cd \GEOTRANS
```

3. Copy the archive to the GEOTRANS directory. For example:

```
C:\>cp D:\win_user.zip C:\GEOTRANS
```

4. Use PKUNZIP to unpack the archive.

```
C:\GEOTRANS>pkunzip win_user.zip
```

Of course, you may also use the Windows desktop to perform these steps, creating a GEOTRANS home directory, copying the ZIP archive into that directory, and then unzipping it.

GEOTRANS 3.3 for Windows users is also available in self installation InstallAnywhere package. After downloading the installation file from the web-site, double click on install.exe and follow on screen instructions to complete the installation.

GEOTRANS 3.3 InstallAnywhere package supports silent installation. To perform silent installation:

1. Create the properties file installer.properties in C:\Temp directory

```
C:\> install.exe -r c:\Temp
```

2. Specify the installation directory by modifying C:\Temp\installer.properties.

Document No. 5034289

Date: 23 October 2012

3. Perform silent installation

```
C:\> install.exe -i silent -f C:\Temp\installer.properties
```

2.2 STARTING GEOTRANS

The Java GEOTRANS GUI is contained in a Java archive file named `MSPCCS.jar`. Copies of this file are located in `.../GEOTRANS3/linux`, `.../GEOTRANS3/solaris` and the `.../GEOTRANS3/win` directories.

To start GEOTRANS, execute the start up script `runGeotrans.sh` (for Unix) or `runGeotrans.bat` (for Windows). It is also possible for you to create a shortcut for the GEOTRANS startup script and place it on your desktop. Once you have done this, you can run GEOTRANS by double clicking on the shortcut icon.

The Java version of GEOTRANS requires the Java Platform Standard Edition, Version 1.5 or later. It can be downloaded at no cost from <http://java.sun.com/j2se> for Solaris, Linux and Windows. We recommend using JRE version 1.6, update 35 or later, which addresses all known vulnerability issues in the earlier versions of JRE.

For the InstallAnywhere installation, double click on the short cut icon or double click on file `MSP_GEOTRANS3.exe` in directory `<installation_directory>\GEOTRANS` to start GEOTRANS.

2.2.1 REQUIRED DATA FILES

GEOTRANS requires several data files that contain datum, ellipsoid, and geoid separation information. The following data files are normally located in the `./data` directory, and GEOTRANS looks for them there by default:

- **3_param.dat** – the data file containing the datum shift parameters for 3-parameter local datums.
- **7_param.dat** – the data file containing the datum shift parameters for 7-parameter local datums.
- **egm96.grd** – the data file containing the Earth Gravity Model 1996 (EGM96) geoid separation values at 15 minute intervals.
- **egm84.grd** – the data file containing the Earth Gravity Model 1984 (EGM84) geoid separation values at 10 degree intervals.

Document No. 5034289

Date: 23 October 2012

- **wwgrid.bin** – the data file containing the Earth Gravity Model 1984 (EGM84) geoid separation values at 30 minute intervals.
- **Und_min2.5x2.5_egm2008_WGS84_TideFree_reformatted** – the data file containing the Earth Gravity Model 2008 (EGM2008) geoid separation values at 2.5 minute intervals.
- **ellips.dat** – the data file containing the standard ellipsoid parameters.

As an alternative, you can define the environment variable MSPCCS_DATA, and place the files in the directory identified by this variable.

NOTE: To speed up the initialization, GeoTrans populates only a small subset of the original EGM 2008 grid. This provides a reasonably-sized working grid that is large enough to avoid frequent reloads of the area-of-interest grid for individual user jobs. In order to load the full EGM 2008 grid, set environment variable EGM2008_GRID_USAGE to FULL.

2.3 BASIC OPERATION

The GEOTRANS main window will appear as shown in Figure 2-1. At the top of the window is the Title Bar, which includes the standard window manipulation controls. Just underneath the Title Bar is the Menu Bar, which contains seven pull-down menus: File, Edit, Options, Datum, Ellipsoid, Convert, and Help.

The main portion of the window is divided into upper and lower halves. Each half contains fields and other controls that indicate the currently selected datum and ellipsoid, coordinate

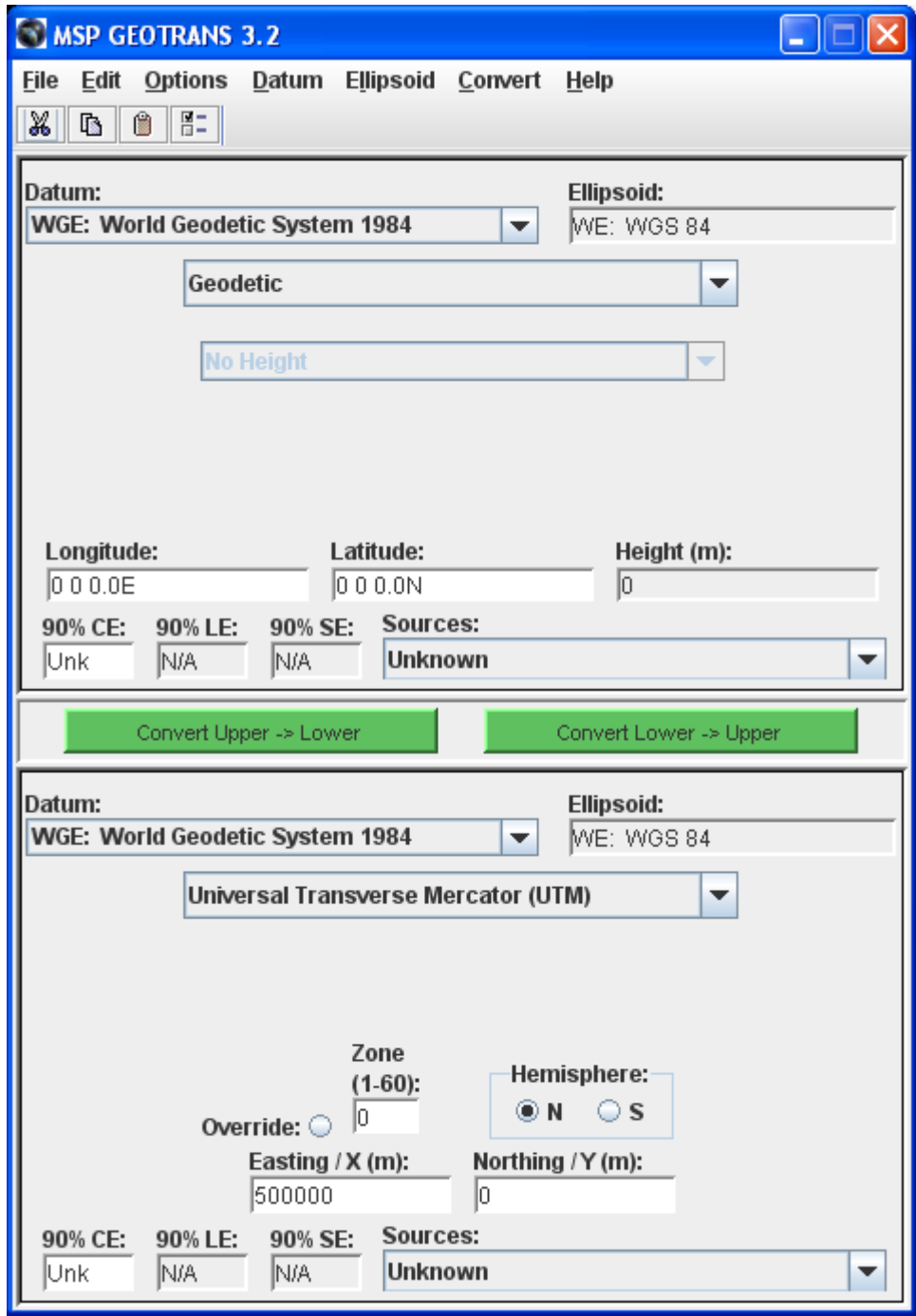

Figure 2-1. GEOTRANS Main Window

reference frame, any associated parameters, and coordinates, as well as 90% circular (horizontal), linear (vertical), and spherical error values. Separating the upper and lower halves of the window are two Convert buttons. The button on the left, Convert: Upper-to-Lower, converts the coordinates in the upper half of the window to the coordinate reference frame specified in the

lower half of the window, outputting the results to the lower coordinate fields. The button on the right, Convert: Lower-to-Upper, does the opposite, converting the coordinates in the lower half of the window, and outputting the results to the upper coordinate fields. These buttons are color coded according to the compatibility of the currently selected datum and coordinate system combination. The buttons will be green when the currently selected datum and coordinate system combination will not produce conversion warnings or errors. The buttons will be yellow when the currently selected datum and coordinate system combination will produce conversion warnings. The buttons will be red when the currently selected datum and coordinate system combination will produce conversion errors.

To convert a set of coordinates from one coordinate reference frame to another, and/or transform it from one datum to another, follow these steps:

1. If the desired input coordinate reference frame type is not already displayed in the upper half of the window, select the desired entry from the pull-down list. The upper half of the window will be updated to display the appropriate parameter and coordinate fields for the selected input coordinate reference frame type.
2. If the desired input datum is not already displayed in the upper half of the window, select the desired datum using the Datum pull-down list. Click on the arrow to open the list, use the scroll bars if necessary to bring the desired entry into view, and then select it by clicking on it. The datum list contains global datums (WGS-84 and WGS-72) first, followed by seven-parameter local datums, and then by local 3-parameter datums, with each section in alphabetical order. When you select a datum, the Ellipsoid field is updated to show the code and name of the ellipsoid associated with the selected datum. Note: A specific ellipsoid cannot be selected directly.
3. If the input coordinate reference frame has any parameters associated with it (e.g., a central meridian) and the default parameter values displayed in the upper half of the window are not the desired values, change the parameter values by selecting the displayed values and typing over them.
4. Enter the input coordinates in the fields displayed in the upper half of the window by selecting each field and typing over its contents. Optionally, specify the accuracy of the input coordinates by entering values, in meters, in the 90%CE, 90%LE, and 90%SE fields, or by selecting an entry from the Sources pull-down menu.
5. If the desired output coordinate reference frame type is not already displayed in the lower half of the window, select the desired entry from the pull-down list. The lower half of the

window will be updated to display the appropriate parameter and coordinate fields for the selected output coordinate reference frame type.

6. If the desired output datum is not already displayed in the lower half of the window, select the desired datum using the Datum pull-down list, just as for the input datum.
7. If the output coordinate reference frame has any parameters associated with it (e.g., a central meridian) and the default parameter values displayed in the lower half of the window are not the desired values, change the parameter values by selecting the displayed values and typing over them.
8. Click on the Convert: Upper-to-Lower button. The output coordinates will be displayed in the coordinate fields in the lower half of the window. The 90% circular, linear, and spherical error values will also be updated.

The following simple example will illustrate these steps. Given a set of Military Grid Reference System (MGRS) coordinates read from a map of Korea based on the Tokyo datum, we want to convert them to Geodetic coordinates based on the WGS 84 datum. The above steps would be carried out as follows:

1. Select MGRS from the pull-down list in the upper half of the window. The upper half of the window will be updated to display an MGRS Coordinate String field where the input coordinates can be entered.
2. Select the Tokyo datum (for Korea, TOY-B) using the Datum pull-down in the upper half of the window. The Ellipsoid field is updated to show the code and name of the ellipsoid associated with the Tokyo datum.
3. MGRS coordinates have no parameters, so this step can be skipped.
4. Enter the input coordinates in the MGRS Coordinate String field displayed in the upper half of the window by selecting the field and typing in the coordinates.
5. Select Geodetic Coordinates from the pull-down list in the lower half of the window. The lower half of the window will be updated to display Latitude, Longitude, and Height fields in which the results will be displayed, along with a set of height type radio buttons.
6. Since WGS 84 is the default datum, this step can be skipped.
7. The height associated with a set of Geodetic coordinates can be either an Ellipsoid Height, which is measured relative to the surface of the selected ellipsoid, or a Geoid/MSL height, which is measured relative to the surface of the geoid, for example,

defined by the Earth Gravity Model 1996 (EGM 96). The set of radio buttons displayed allows you to select which type of output height is desired. Since MGRS coordinates do not include a height, the selection is automatically set to the No Height radio button, and the Height field is grayed out.

8. Click on the Convert: Upper-to-Lower button. The resulting geodetic coordinates will be displayed in the Latitude and Longitude fields in the Output Area of the window.

Note that the order of the above steps is arbitrary. The only constraints are that MGRS coordinates must be selected before the input coordinates can be entered, Geodetic coordinates must be selected before the height type can be specified, and that any parameters and input coordinates must be entered before the Convert: Upper-to-Lower button is clicked.

Section 3 describes GEOTRANS interactive coordinate conversion and datum transformation capabilities in more detail.

NOTE: In GEOTRANS 3.2 and 3.3 an iterative algorithm is used in the Geocentric to Geodetic conversion to achieve better accuracy. If a user needs to revert back to the legacy non-iterative GEOTRANS algorithm, then an environment variable MSPCCS_USE_LEGACY_GEOTRANS needs to be defined before starting GEOTRANS.

2.4 EXITING GEOTRANS

To exit the GEOTRANS application, select the Exit command in the File menu. This causes the GEOTRANS application to immediately exit.

3. COORDINATE CONVERSION & DATUM TRANSFORMATION

This section provides additional detail for using GEOTRANS interactively for coordinate conversion and datum transformation, expanding on the basic instructions given in paragraph 2.3. Paragraph 3.1 addresses datum selection and datum transformations, while paragraph 3.2 addresses coordinate reference frame selection, and the entry of coordinate reference frame parameters and coordinate values. Paragraph 3.3 describes the various options that can be set to control the appearance of displayed outputs. Paragraph 3.4 describes the creation and deletion of user-defined datums and ellipsoids.

3.1 DATUM TRANSFORMATIONS

A datum defines a particular model of the earth. Global datums, such as WGS 84, are intended to provide the best possible fit over the entire earth's surface. Local datums are optimized for a particular region, often a country or group of countries, an island, or an island group. Local datums frequently are defined in families, which include a mean solution for the overall region (e.g., EUR-M, for all of Europe) and individual variants for specific countries or areas (e.g., EUR-A for Western Europe). GEOTRANS supports datum transformations among WGS-84 (the current DoD standard datum), WGS-72 (which was the previous standard), and more than 200 local datums. GEOTRANS integrates datum transformations with coordinate conversion operations.

Each datum references a particular ellipsoid, which defines the overall size and shape of the earth. There are approximately two dozen standard ellipsoids that GEOTRANS supports. Each datum also specifies where the center of the ellipsoid is located, relative to the center of the WGS-84 ellipsoid. Most local datums are defined using three parameters, which define the location of the center of the earth in that datum in terms of X, Y, and Z shifts from the center of the WGS-84 ellipsoid. To transform between geocentric coordinates defined in a local datum and geocentric coordinates defined in the WGS-84 datum, these shift values are simply added or subtracted, as appropriate. A very small number of local datums are defined using seven parameters: the three shift parameters, the three rotation angles (one for each axis), and a scale factor.

Because it is far more common to deal with geodetic coordinates, rather than geocentric coordinates, approximate methods of performing datum transformations without having to convert to geocentric coordinates have been developed. GEOTRANS uses such a method, called Molodensky's method, for most datum transformations. Whenever the input to GEOTRANS is

Document No. 5034289

Date: 23 October 2012

in geodetic coordinates, or in any map projection derived from geodetic coordinates, Molodensky's method is used. When the input is already in geocentric coordinates, the desired output is in geocentric coordinates, or the input coordinates are located near one of the poles, where Molodensky's method cannot be used, the 3-parameter method is used. Transformations involving 7-parameter datums, and transformations between WGS-84 and WGS-72, are special cases.

If you specify the same datum for both input and output, GEOTRANS does not perform any datum transformation operations. If the input and output datums are different, a datum transformation will be performed. Usually two datum transformations are actually carried out: from the input datum to WGS-84, and then from WGS-84 to the output datum.

WGS-84 is the default datum for both input and output.

To select a particular datum for either input or output, click on the arrow associated with the appropriate Datum pull-down list. A scrolling list of datum codes and names will appear, in alphabetical order according to the datum code. Use the scroll bars to find the desired datum, then click on the entry to select it. The Ellipsoid field to the right of the Datum field is automatically updated to display the ellipsoid associated with the selected datum. You cannot select an ellipsoid directly.

Two cases are worth noting. First, the Old Hawaiian (OHA) datum can be used with two different ellipsoids, either the Clarke 1866 (CC) ellipsoid or the International (IN) ellipsoid. To accommodate this, there are two sets of entries in the datum list for the Old Hawaiian datum. One set of entries uses the code OHA and the CC ellipsoid, while the other uses the code OHI and the IN ellipsoid. Second, the mean European 1950 datum (EUR-M) and the mean Ordinance Survey of Great Britain (OGB-M) have both 3-parameter and 7-parameter versions. Both versions are included in the datum list, but the codes for the 7-parameter versions have been modified to EUR-7 and OGB-7 to eliminate ambiguity.

Since the parameters that are used in datum transformations are estimates, datum transformations are not perfectly accurate. For this reason, GEOTRANS displays standard error information at the bottom of each half of the main window. Standard error estimates are computed from the source accuracy information provided by the user, if any, and the available datum shift parameter accuracy information for both the source and target datum. Three values are displayed. A 90% circular error (CE), in meters, estimates the horizontal accuracy of the output coordinates. A 90% linear error (LE), in meters, estimates the vertical accuracy of geodetic heights. A 90% spherical error (SE), in meters, estimates the three-dimensional accuracy of geocentric and local

Cartesian coordinates. In some cases, where the accuracy of the datum transformation parameters is not known, the string "Unk" (i.e., unknown) is displayed.

3.2 COORDINATE REFERENCE FRAMES

GEOTRANS currently performs coordinate conversions among thirty-five different types of coordinate systems, map projections, grids, and coding schemes:

- Geodetic coordinates
- World Geographic Reference System (GEOREF) coordinates
- Global Area Reference System (GARS) coordinates
- Geocentric coordinates
- Local Cartesian coordinates
- Military Grid Reference System (MGRS) coordinates
- United States National Grid (USNG) coordinates
- Universal Transverse Mercator (UTM) coordinates
- Universal Polar Stereographic (UPS) coordinates
- Albers Equal Area Conic projection
- Azimuthal Equidistant projection(S)
- Bonne projection
- British National Grid coordinates
- Cassini projection
- (Lambert) Cylindrical Equal Area projection
- Eckert IV projection (S)
- Eckert VI projection (S)
- Equidistant Cylindrical (also known as Equirectangular) projection (S)
- Gnomonic projection (S)
- Lambert Conformal Conic projection (with 1 Standard Parallel)
- Lambert Conformal Conic projection (with 2 Standard Parallels)
- Mercator projection (with Standard Parallel)

Document No. 5034289

Date: 23 October 2012

- Mercator projection (with Scale Factor)
- Miller Cylindrical projection (S)
- Molleweide projection (S)
- New Zealand Map Grid projection
- Ney's (Modified Lambert Conformal Conic) projection
- Oblique Mercator projection
- Orthographic projection (S)
- Polar Stereographic projection (with Standard Parallel)
- Polar Stereographic projection (with Scale Factor)
- Polyconic projection
- Sinusoidal projection
- Stereographic projection (S)
- Transverse Cylindrical Equal Area projection
- Transverse Mercator projection
- Van der Grinten projection
- F-16 Grid Reference System

Those projections identified above with an (S) use a spherical representation of the Earth, rather than an ellipsoid. For these projections, the sphere that is used is the authalic sphere, that is, the sphere that has the same surface area as the currently selected ellipsoid.

Each type of supported projection is further defined by a collection of parameters that determine where the center of the projection is located (in geodetic coordinates), the scale factor of the projection, and any offsets to the projection coordinates.

GEOTRANS treats both geocentric and geodetic coordinates as its core coordinate systems. All other types of input coordinates are first converted to either geodetic or geocentric coordinates. Then, if necessary, a datum transformation is performed, as described in the previous section. Finally, if necessary, the intermediate geodetic or geocentric coordinates are converted to the specified output coordinate system or map projection.

3.2.1 COORDINATE REFERENCE FRAME SELECTION

To select a particular type of coordinate reference frame, select it from the pull-down list in the upper or lower half of the main window, as appropriate. The upper or lower half of the window immediately changes to reflect the selection. Any parameter fields, as well as the coordinate fields in that half of the window are reset to default values.

3.2.2 PARAMETER/COORDINATE FIELD ENTRY

Once the desired input and output coordinate reference frames have been selected, you must fill in any associated parameters, as well as the input coordinate values. In general, this is done by selecting a field, and then typing in a new value. Field values can be entered in any order.

To select a particular field, click inside it using the mouse. You can also navigate from one field or control to another by using the tab key on the keyboard. The tab key moves the input focus to the next field, in top to bottom, left to right order. Shift tab moves the focus to the previous field.

There are several different types of parameter and coordinate fields, as well as other types of controls. These are described below, organized according to the type of coordinate reference frame with which they are used.

3.2.2.1 Geodetic Coordinates

The Height Type is the only parameter. A pull-down list is used to specify which type of height value is being input, or is desired as output. The Height Type can be:

- No Height – used to support two dimensional coordinate conversions.
- Ellipsoid Height – height relative to the ellipsoid surface.
- MSL-EGM2008-2.5M-BCS Height – height relative to the EGM 2008 geoid, using a 2.5-minute grid and a bicubic spline interpolation method.
- MSL-EGM96-15M-BL Height – height relative to the EGM 96 geoid, using a 15-minute grid and a bilinear interpolation method.
- MSL-EGM96-VG-NS Height – height relative to the EGM 96 geoid, using a variable resolution grid and a natural spline interpolation method; this model is included for compatibility with older systems.
- MSL-EGM84-10D-BL Height – height relative to the EGM 84 geoid, using a 10-degree grid and a bilinear interpolation method; this model is included for compatibility with older systems.

Document No. 5034289

Date: 23 October 2012

- MSL-EGM84-10D-NS Height – height relative to the EGM 84 geoid, using a 10-degree grid and a natural spline interpolation method; this model is included for compatibility with older systems.
- MSL-EGM84-30M-BL Height – height relative to the EGM 84 geoid, using a 30-minute grid and a bilinear interpolation method; this model is included for compatibility with older systems and is more accurate than the MSL-EGM84-10D-BL Height method.

The Height Type selection is automatically set to No Height whenever the other currently selected coordinate reference system is two-dimensional.

Geodetic coordinates consist of three fields labeled Latitude, Longitude, and Height.

The Latitude field can be in any of three different formats: degrees (DD.FFFFFFFF, where DD represents the integer degree value, and FFFFFFFF represents a fractional degree value with up to eight decimal places); degrees/minutes (DD MM.FFFFFFF, where MM represents the integer minute value, and FFFFFFF represents a fractional minute value with up to six decimal places); or degrees/minutes/seconds (DD MM SS.FFFF) where SS represents the integer seconds value, and FFFF represents a fractional second value with up to four decimal places. In the latter two formats, the minute and second subfields are optional. The degree, minute, and second subfields can be separated by slashes ('/') or colons (':') as well as by spaces. The value can be preceded by an optional sign ('+' or '-'), OR it can be followed by a hemisphere letter ('N' or 'S'), but not both. Latitude values must be in the range from -90 (90S) to +90 (90N).

The Longitude field is very similar to the Latitude field, except that the degree subfield can contain three digits, and the hemisphere letter must be either 'W' or 'E.' Longitude values must be in the range from -180 (180W) to +360.

The Height field indicates the height, in meters, relative to the reference surface specified by the Height Type parameter. Whenever No Height is selected, the Height field is grayed out. Legal height values are optionally signed real values, with up to three decimal places. The height field is required to have a valid value, though it is only used when converting from Geodetic to Geocentric or Local Cartesian coordinates, or when converting between ellipsoid heights and geoid/MSL heights. Zero is the default value.

See Appendix A for more details on geodetic coordinates.

3.2.2.2 GEOREF Coordinates

There are no parameters.

Document No. 5034289

Date: 23 October 2012

GEOREF coordinates consist of a single alphanumeric string made up of four letters followed by up to ten digits.

See Appendix A for more details on GEOREF coordinates.

3.2.2.3 GARS Coordinates

There are no parameters.

GARS coordinates consist of a single alphanumeric string made up of three digits, followed by two letters and two digits.

See Appendix A for more details on GARS coordinates.

3.2.2.4 Geocentric Coordinates

There are no parameters.

Geocentric coordinates consist of three fields labeled X, Y, and Z. The legal values for these fields are optionally signed real values, in meters, with up to three decimal places.

See Appendix A for more details on geocentric coordinates.

3.2.2.5 Local Cartesian Coordinates

A particular Local Cartesian coordinate system is defined by the following parameters:

- Origin Latitude – A latitude value that specifies the parallel where the origin of the local coordinate system is located. Any legal latitude value is valid in this field.
- Origin Longitude – A longitude value that specifies the meridian where the origin of the local coordinate system is located. Any legal longitude value is valid in this field.
- Origin Height – A value in meters that specifies the height above the reference ellipsoid surface where the origin or the local coordinate system is located. Any optionally signed real value, with up to three decimal places, is legal.
- Orientation – A rotation angle (identical in format to a longitude) that specifies the angle clockwise from north to the positive Y coordinate axis of the local coordinate system. Any legal longitude value is valid in this field.

The origin of a Local Cartesian coordinate system is typically a point on, or near, the surface of the reference ellipsoid. The location of the origin is specified by a set of geodetic coordinates (latitude, longitude, and ellipsoid height). The XY plane is tangent to the reference ellipsoid at the origin. By default, at the local origin, the positive X axis points east and the positive Y axis

Document No. 5034289

Date: 23 October 2012

points north, while the positive Z axis points up. However, the coordinate system can be rotated clockwise about the Z axis, as specified by the orientation angle.

See Appendix A for more details on Local Cartesian coordinates.

3.2.2.6 MGRS Coordinates

There are no parameters.

MGRS coordinates consist of a single alphanumeric string made up of from zero to two digits, followed by three letters, followed by up to ten digits.

MGRS coordinates are in the non-polar (i.e., UTM-based) form between 80° S and 84° N, and in polar (i.e., UPS-based) form south of 80° S, and north of 84° N. MGRS coordinates follow the general rule that the southern and western boundaries of an area are considered to be part of that area, while the northern and eastern boundaries are not.

See Appendix A for more details on MGRS coordinates.

3.2.2.7 USNG Coordinates

There are no parameters.

USNG coordinates consist of a single alphanumeric string made up of from zero to two digits, followed by three letters, followed by up to ten digits. USNG coordinates are identical to MGRS coordinates, except that USNG coordinates use a single pattern of 100,000-meter grid square designators (the AA pattern) regardless of the ellipsoid.

USNG coordinates are in the non-polar (i.e., UTM-based) form between 80° S and 84° N, and in polar (i.e., UPS-based) form south of 80° S, and north of 84° N. USNG coordinates follow the general rule that the southern and western boundaries of an area are considered to be part of that area, while the northern and eastern boundaries are not.

See Appendix A for more details on USNG coordinates.

3.2.2.8 Universal Transverse Mercator (UTM) Coordinates

There are no parameters.

UTM coordinates consist of a zone number in the range from 1 to 60, a hemisphere indicator (N/S) and two fields labeled Easting/X and Northing/Y. The zone number is entered as a one or two digit number. The hemisphere is specified using a pair of radio buttons. Click on the button labeled 'N' for the northern hemisphere or on the button labeled 'S' for the southern hemisphere.

Document No. 5034289

Date: 23 October 2012

When UTM is the output coordinate system, you may optionally specify a particular UTM zone in which the output coordinates are to be represented. Click on the Override radio button to activate this option, and fill in the desired zone number. The input coordinates must fall within the specified zone, or within its overlap areas with the two adjacent zones.

UTM coordinates are valid between 80.5° S and 84.5° N, which includes a 0.5° overlap area with each of the two polar regions. UTM coordinates that are located within either of these two overlap areas will be converted to the polar form of MGRS or USNG coordinates. UTM coordinates follow the general rule that the southern and western boundaries of an area are considered to be part of that area, while the northern and eastern boundaries are not.

The range of valid UTM easting coordinates is between 100,000m and 900,000m. The range of valid UTM northing coordinates is from zero to 10,000,000m.

The UTM override is valid for the two zones that are adjacent, on either side, to the “natural” zone of the point.

See Appendix A for more details on UTM coordinates.

3.2.2.9 Universal Polar Stereographic (UPS) Coordinates

There are no parameters.

UPS coordinates consist of a hemisphere indicator (N/S) and two fields labeled Easting/X and Northing/Y. The hemisphere is specified using a pair of radio buttons. Click on the button labeled ‘N’ for the North polar zone or on the button labeled ‘S’ for the South polar zone. The legal values for the Easting/X and the Northing/Y fields are optionally signed real values, in meters, with up to three decimal places.

UPS coordinates are valid south of 79.5° S and north of 83.5° N, which includes a 0.5° overlap area adjacent to each of the polar regions. UPS coordinates that are located within either of these two overlap areas will be converted to the non-polar form of MGRS or USNG coordinates. UPS coordinates follow the general rule that the southern and western boundaries of an area are considered to be part of that area, while the northern and eastern boundaries are not.

The range of valid UPS easting coordinates is between zero and 4,000,000m. The range of valid UPS northing coordinates is also from zero to 4,000,000m.

See Appendix A for more details on UPS coordinates.

3.2.2.10 Albers Equal Area Conic Projection

A particular Albers Equal Area Conic projection is defined by the following parameters:

- Central Meridian – A longitude value that specifies the horizontal origin of the projection. Any legal longitude value is valid in this field.
- Origin Latitude – A latitude value that specifies the vertical origin of the projection. Any legal latitude value is valid in this field.
- 1st Standard Parallel – A latitude value that specifies one of the two the parallels where the point scale factor is 1.0. The 1st Standard Parallels must be greater than 90°S and less than 90°N. Both Standard Parallels cannot be located at the equator, and they cannot be at equal latitudes in different hemispheres.
- 2nd Standard Parallel – A latitude value that specifies one of the two the parallels where the point scale factor is 1.0. The 2nd Standard Parallels must be greater than 90°S and less than 90°N. Both Standard Parallels cannot be located at the equator, and they cannot be at equal latitudes in different hemispheres.
- False Easting – A coordinate value in meters that specifies the Easting/X coordinate at the origin of the projection (i.e., the Central Meridian). Any optionally signed real value, with up to three decimal places, is legal.
- False Northing – A coordinate value in meters that specifies the Northing/Y coordinate at the origin of the projection (i.e., the Origin Latitude). Any optionally signed real value, with up to three decimal places, is legal.

Albers Equal Area Conic projection coordinates consist of two fields labeled Easting/X and Northing/Y. The legal values for the Easting/X and the Northing/Y fields are optionally signed real values, with up to three decimal places, in meters.

The ranges of valid Albers Equal Area Conic easting and northing coordinates are between zero and 40,000,000m from the projection origin.

See Appendix A for more details on Albers Equal Area Conic projection coordinates.

3.2.2.11 Azimuthal Equidistant Projection

A particular Azimuthal Equidistant projection is defined by the following parameters:

- Central Meridian – A longitude value that specifies the horizontal origin of the projection. Any legal longitude value is valid in this field.

Document No. 5034289

Date: 23 October 2012

- Origin Latitude – A latitude value that specifies the vertical origin of the projection. Any legal latitude value is valid in this field.
- False Easting – A coordinate value in meters that specifies the Easting/X coordinate at the origin of the projection (i.e., the Central Meridian). Any optionally signed real value, with up to three decimal places, is legal.
- False Northing – A coordinate value in meters that specifies the Northing/Y coordinate at the origin of the projection (i.e., the Origin Latitude). Any optionally signed real value, with up to three decimal places, is legal.

Because the Azimuthal Equidistant projection is only defined for a sphere, GEOTRANS uses an authalic sphere (i.e., a sphere with the same surface area as the ellipsoid associated with the specified datum).

Azimuthal Equidistant projection coordinates consist of two fields labeled Easting/X and Northing/Y. The legal values for the Easting/X and the Northing/Y fields are optionally signed real values, with up to three decimal places, in meters.

The range of valid Azimuthal Equidistant easting and northing coordinates depends on the ellipsoid parameters, but is roughly between zero and 20,000,000m from the projection origin.

See Appendix A for more details on Azimuthal Equidistant projection coordinates.

3.2.2.12 British National Grid Coordinates

There are no parameters.

The British National Grid can only be used with the Ordnance Survey of Great Britain 1936 (OGB) family of datums, which are based on the Airy ellipsoid.

British National Grid coordinates consist of a single alphanumeric string made up of two letters, followed by up to ten digits.

GEOTRANS limits the latitude values for British National Grid to between 49.5° N and 61.5° N. Longitude values are limited to between 10° W and 3.5° E. The valid range of easting values is from -133134.0 to 759961.0. The valid range of northing values is from -14829.0 to 1257875.0.

See Appendix A for more details on British National Grid coordinates.

3.2.2.13 Bonne Projection

A particular Bonne projection is defined by the following parameters:

- Central Meridian – A longitude value that specifies the horizontal origin of the projection. Any legal longitude value is valid in this field.
- Origin Latitude – A latitude value that specifies the vertical origin of the projection. Any legal latitude value is valid in this field.
- False Easting – A coordinate value in meters that specifies the Easting/X coordinate at the origin of the projection (i.e., the Central Meridian). Any optionally signed real value, with up to three decimal places, is legal.
- False Northing – A coordinate value in meters that specifies the Northing/Y coordinate at the origin of the projection (i.e., the Origin Latitude). Any optionally signed real value, with up to three decimal places, is legal.

Bonne projection coordinates consist of two fields labeled Easting/X and Northing/Y. The legal values for the Easting/X and the Northing/Y fields are optionally signed real values, with up to three decimal places, in meters.

The range of valid Bonne easting coordinates depends on the ellipsoid parameters, but is roughly between zero and 20,500,000m from the projection origin defined. The range of valid Bonne northing coordinates depends on the ellipsoid parameters, but is roughly between zero and 23,500,000m from the projection origin.

See Appendix A for more details on Bonne projection coordinates.

3.2.2.14 Cassini Projection

A particular Cassini projection is defined by the following parameters:

- Central Meridian – A longitude value that specifies the horizontal origin of the projection. Any legal longitude value is valid in this field.
- Origin Latitude – A latitude value that specifies the vertical origin of the projection. Any legal latitude value is valid in this field.
- False Easting – A coordinate value in meters that specifies the Easting/X coordinate at the origin of the projection (i.e., the Central Meridian). Any optionally signed real value, with up to three decimal places, is legal.
- False Northing – A coordinate value in meters that specifies the Northing/Y coordinate at the origin of the projection (i.e., the Origin Latitude). Any optionally signed real value, with up to three decimal places, is legal.

Document No. 5034289

Date: 23 October 2012

Cassini projection coordinates consist of two fields labeled Easting/X and Northing/Y. The legal values for the Easting/X and the Northing/Y fields are optionally signed real values, with up to three decimal places, in meters.

The range of valid Cassini easting coordinates depends on the ellipsoid parameters, but is roughly between zero and 20,000,000m from the projection origin. The range of valid Cassini northing coordinates depends on the ellipsoid parameters, but is roughly between zero and 57,000,000m from the projection origin.

GEOTRANS issues a distortion warning for points located more than 4° of longitude from the Central Meridian.

See Appendix A for more details on Cassini projection coordinates.

3.2.2.15 Cylindrical Equal Area Projection

A particular Cylindrical Equal Area projection is defined by the following parameters:

- Central Meridian – A longitude value that specifies the horizontal origin of the projection. Any legal longitude value is valid in this field.
- Origin Latitude – A latitude value that specifies the vertical origin of the projection. Any legal latitude value is valid in this field.
- False Easting – A coordinate value in meters that specifies the Easting/X coordinate at the origin of the projection (i.e., the Central Meridian). Any optionally signed real value, with up to three decimal places, is legal.
- False Northing – A coordinate value in meters that specifies the Northing/Y coordinate at the origin of the projection (i.e., the Origin Latitude). Any optionally signed real value, with up to three decimal places, is legal.

Cylindrical Equal Area projection coordinates consist of two fields labeled Easting/X and Northing/Y. The legal values for the Easting/X and the Northing/Y fields are optionally signed real values, with up to three decimal places, in meters.

The range of valid Cylindrical Equal Area easting coordinates depends on the ellipsoid parameters, but is roughly between zero and 20,000,000m from the projection origin. The range of valid Cylindrical Equal Area northing coordinates depends on the ellipsoid parameters, but is roughly between zero and 6,000,000m from the projection origin.

See Appendix A for more details on Cylindrical Equal Area projection coordinates.

3.2.2.16 Eckert IV Projection

A particular Eckert IV projection is defined by the following parameters:

- Central Meridian – A longitude value that specifies the horizontal origin of the projection. Any legal longitude value is valid in this field.
- False Easting – A coordinate value in meters that specifies the Easting/X coordinate at the origin of the projection (i.e., the Central Meridian). Any optionally signed real value, with up to three decimal places, is legal.
- False Northing – A coordinate value in meters that specifies the Northing/Y coordinate at the origin of the projection (i.e., the Origin Latitude). Any optionally signed real value, with up to three decimal places, is legal.

The Origin Latitude of the Eckert IV projection is fixed at the Equator.

Because the Eckert IV projection is only defined for a sphere, GEOTRANS uses an authalic sphere (i.e., a sphere with the same surface area as the ellipsoid associated with the specified datum).

Eckert IV projection coordinates consist of two fields labeled Easting/X and Northing/Y. The legal values for the Easting/X and the Northing/Y fields are optionally signed real values, with up to three decimal places, in meters.

The range of valid Eckert IV easting coordinates depends on the ellipsoid parameters, but is roughly between zero and 17,000,000m from the projection origin. The range of valid Eckert IV northing coordinates depends on the ellipsoid parameters, but is roughly between zero and 8,000,000m from the projection origin.

See Appendix A for more details on Eckert IV projection coordinates.

3.2.2.17 Eckert VI Projection

A particular Eckert VI projection is defined by the following parameters:

- Central Meridian – A longitude value that specifies the horizontal origin of the projection. Any legal longitude value is valid in this field.
- False Easting – A coordinate value in meters that specifies the Easting/X coordinate at the origin of the projection (i.e., the Central Meridian). Any optionally signed real value, with up to three decimal places, is legal.

- False Northing – A coordinate value in meters that specifies the Northing/Y coordinate at the origin of the projection (i.e., the Origin Latitude). Any optionally signed real value, with up to three decimal places, is legal.

The Origin Latitude of the Eckert VI projection is fixed at the Equator.

Because the Eckert VI projection is only defined for a sphere, GEOTRANS uses an authalic sphere (i.e., a sphere with the same surface area as the ellipsoid associated with the specified datum).

Eckert VI projection coordinates consist of two fields labeled Easting/X and Northing/Y. The legal values for the Easting/X and the Northing/Y fields are optionally signed real values, with up to three decimal places, in meters.

The range of valid Eckert VI easting coordinates depends on the ellipsoid parameters, but is roughly between zero and 18,000,000m from the projection origin. The range of valid Eckert VI northing coordinates depends on the ellipsoid parameters, but is roughly between zero and 8,000,000m from the projection origin.

See Appendix A for more details on Eckert VI projection coordinates.

3.2.2.18 Equidistant Cylindrical Projection

A particular Equidistant Cylindrical projection is defined by the following parameters:

- Central Meridian – A longitude value that specifies the horizontal origin of the projection. Any legal longitude value is valid in this field.
- Standard Parallel – A latitude value that specifies the parallel where the scale factor of the projection is 1.0. Any legal latitude value is valid in this field.
- False Easting – A coordinate value in meters that specifies the Easting/X coordinate at the origin of the projection (i.e., the Central Meridian). Any optionally signed real value, with up to three decimal places, is legal.
- False Northing – A coordinate value in meters that specifies the Northing/Y coordinate at the origin of the projection (i.e., the equator). Any optionally signed real value, with up to three decimal places, is legal.

Because the Equidistant Cylindrical projection is only defined for a sphere, GEOTRANS uses an authalic sphere (i.e., a sphere with the same surface area as the ellipsoid associated with the specified datum).

Equidistant Cylindrical projection coordinates consist of two fields labeled Easting/X and Northing/Y. The legal values for the Easting/X and the Northing/Y fields are optionally signed real values, with up to three decimal places, in meters.

The range of valid Equidistant Cylindrical easting coordinates depends on the ellipsoid parameters, but is roughly between zero and 20,000,000m from the projection origin. The range of valid Equidistant Cylindrical northing coordinates depends on the ellipsoid parameters, but is roughly between zero and 10,000,000m from the projection origin.

See Appendix A for more details on Equidistant Cylindrical projection coordinates.

3.2.2.19 Gnomonic Projection

A particular Gnomonic projection is defined by the following parameters:

- Central Meridian – A longitude value that specifies the horizontal origin of the projection. Any legal longitude value is valid in this field.
- Origin Latitude – A latitude value that specifies the vertical origin of the projection. Any legal latitude value is valid in this field. An Origin Latitude value of zero gives the equatorial aspect. An Origin Latitude value of 90 degrees (North or South) gives the polar aspect. Any other Origin Latitude value gives an oblique aspect.
- False Easting – A coordinate value in meters that specifies the Easting/X coordinate at the origin of the projection (i.e., the Central Meridian). Any optionally signed real value, with up to three decimal places, is legal.
- False Northing – A coordinate value in meters that specifies the Northing/Y coordinate at the origin of the projection (i.e., the Origin Latitude). Any optionally signed real value, with up to three decimal places, is legal.

Because the Gnomonic projection is only defined for a sphere, GEOTRANS uses an authalic sphere (i.e., a sphere with the same surface area as the ellipsoid associated with the specified datum).

Gnomonic projection coordinates consist of two fields labeled Easting/X and Northing/Y. The legal values for the Easting/X and the Northing/Y fields are optionally signed real values, with up to three decimal places, in meters.

The ranges of valid Gnomonic easting and northing coordinates are between zero and 40,000,000m from the projection origin.

See Appendix A for more details on Gnomonic projection coordinates.

3.2.2.20 Lambert Conformal Conic (1 Standard Parallel) Projection

A particular Lambert Conformal Conic (1 Standard Parallel) projection is defined by the following parameters:

- Central Meridian – A longitude value that specifies the horizontal origin of the projection. Any legal longitude value is valid in this field.
- Origin Latitude – A latitude value that specifies the vertical origin of the projection. Any legal latitude value is valid in this field.
- Scale Factor – The ratio between distances in the projection and distances on the surface of the reference ellipsoid, at the Origin Latitude. GEOTRANS accepts scale factor values ranging from 0.3 to 3.0.
- False Easting – A coordinate value in meters that specifies the Easting/X coordinate at the origin of the projection (i.e., the Central Meridian). Any optionally signed real value, with up to three decimal places, is legal.
- False Northing – A coordinate value in meters that specifies the Northing/Y coordinate at the origin of the projection (i.e., the Origin Latitude). Any optionally signed real value, with up to three decimal places, is legal.

With this method of specifying the Lambert Conformal Conic parameters, the Origin Latitude is also the single Standard Parallel.

GEOTRANS limits the Origin Latitude to latitude values between 89 59 59.0° S and 89 59 59.0° N.

Lambert Conformal Conic (1 parallel) projection coordinates consist of two fields labeled Easting/X and Northing/Y. The legal values for the Easting/X and the Northing/Y fields are optionally signed real values, with up to three decimal places, in meters.

The ranges of valid Lambert Conformal Conic easting and northing coordinates are between zero and 400,000,000m from the projection origin.

See Appendix A for more details on Lambert Conformal Conic (1 parallel) projection coordinates.

3.2.2.21 Lambert Conformal Conic (2 Standard Parallels) Projection

A particular Lambert Conformal Conic (2 Standard Parallels) projection is defined by the following parameters:

Document No. 5034289

Date: 23 October 2012

- Central Meridian – A longitude value that specifies the horizontal origin of the projection. Any legal longitude value is valid in this field.
- Origin Latitude – A latitude value that specifies the vertical origin of the projection. Any legal latitude value is valid in this field.
- 1st Standard Parallel – A latitude value that specifies one of the two the parallels where the point scale factor is 1.0. The 1st Standard Parallels must be greater than 90°S and less than 90°N. Both Standard Parallels cannot be located at the equator, and they cannot be at equal latitudes in different hemispheres.
- 2nd Standard Parallel – A latitude value that specifies one of the two the parallels where the point scale factor is 1.0. The 2nd Standard Parallels must be greater than 90°S and less than 90°N. Both Standard Parallels cannot be located at the equator, and they cannot be at equal latitudes in different hemispheres.
- False Easting – A coordinate value in meters that specifies the Easting/X coordinate at the origin of the projection (i.e., the Central Meridian). Any optionally signed real value, with up to three decimal places, is legal.
- False Northing – A coordinate value in meters that specifies the Northing/Y coordinate at the origin of the projection (i.e., the Origin Latitude). Any optionally signed real value, with up to three decimal places, is legal.

GEOTRANS limits the Origin Latitude and both Standard Parallel values to between 89 59 59.0° S and 89 59 59.0° N.

The two standard parallels cannot both be zero, and cannot be equal latitudes in opposite hemispheres, and this would cause the projection surface to become a cylinder.

When the two standard parallels are both set to the same latitude value, the result is a Lambert Conformal Conic projection with one standard parallel at the specified latitude, and with a Scale Factor of 1.0.

Lambert Conformal Conic (2 parallel) projection coordinates consist of two fields labeled Easting/X and Northing/Y. The legal values for the Easting/X and the Northing/Y fields are optionally signed real values, with up to three decimal places, in meters.

The ranges of valid Lambert Conformal Conic easting and northing coordinates are between zero and 400,000,000m from the projection origin.

See Appendix A for more details on Lambert Conformal Conic (2 parallel) projection coordinates.

3.2.2.22 Mercator (Standard Parallel) Projection

A particular Mercator (Standard Parallel) projection is defined by the following parameters:

- Central Meridian – A longitude value that specifies the horizontal center of the projection. Any legal longitude value is valid in this field.
- Standard Parallel – A latitude value that specifies the parallel where the point scale factor is 1.0.
- False Easting – A coordinate value in meters that specifies the Easting/X coordinate at the origin of the projection (i.e., the Central Meridian). Any optionally signed real value, with up to three decimal places, is legal.
- False Northing – A coordinate value in meters that specifies the Northing/Y coordinate at the origin of the projection (i.e., the equator). Any optionally signed real value, with up to three decimal places, is legal.

The Origin Latitude of the Mercator projection is fixed at the Equator.

The Scale Factor field is not an input parameter, but instead is an output. When the Convert button is clicked, the Scale Factor is calculated from the ellipsoid parameters and the Standard Parallel, and the field is updated with the resulting value.

Mercator projection coordinates consist of two fields labeled Easting/X and Northing/Y. The legal values for the Easting/X and the Northing/Y fields are optionally signed real values, with up to three decimal places, in meters.

The range of valid Mercator easting coordinates depends on the ellipsoid parameters, but is roughly between zero and 20,500,000m from the projection origin. The range of valid Mercator northing coordinates depends on the ellipsoid parameters, but is roughly between zero and 23,500,000m from the projection origin.

See Appendix A for more details on Mercator projection coordinates.

3.2.2.23 Mercator (Scale Factor) Projection

A particular Mercator (Scale Factor) projection is defined by the following parameters:

- Central Meridian – A longitude value that specifies the horizontal center of the projection. Any legal longitude value is valid in this field.

- Scale Factor – The ratio between distances in the projection and distances on the surface of the reference ellipsoid, at the Equator. GEOTRANS accepts scale factor values ranging from 0.3 to 3.0.
- False Easting – A coordinate value in meters that specifies the Easting/X coordinate at the origin of the projection (i.e., the Central Meridian). Any optionally signed real value, with up to three decimal places, is legal.
- False Northing – A coordinate value in meters that specifies the Northing/Y coordinate at the origin of the projection (i.e., the equator). Any optionally signed real value, with up to three decimal places, is legal.

The Origin Latitude of the Mercator projection is fixed at the Equator.

Mercator projection coordinates consist of two fields labeled Easting/X and Northing/Y. The legal values for the Easting/X and the Northing/Y fields are optionally signed real values, with up to three decimal places, in meters.

The range of valid Mercator easting coordinates depends on the ellipsoid parameters, but is roughly between zero and 20,500,000m from the projection origin. The range of valid Mercator northing coordinates depends on the ellipsoid parameters, but is roughly between zero and 23,500,000m from the projection origin.

See Appendix A for more details on Mercator projection coordinates.

3.2.2.24 Miller Cylindrical Projection

A particular Miller Cylindrical projection is defined by the following parameters:

- Central Meridian – A longitude value that specifies the horizontal origin of the projection. Any legal longitude value is valid in this field.
- False Easting – A coordinate value in meters that specifies the Easting/X coordinate at the origin of the projection (i.e., the Central Meridian). Any optionally signed real value, with up to three decimal places, is legal.
- False Northing – A coordinate value in meters that specifies the Northing/Y coordinate at the origin of the projection (i.e., the Origin Latitude). Any optionally signed real value, with up to three decimal places, is legal.

The Origin Latitude of the Miller Cylindrical projection is fixed at the Equator.

Because the Miller Cylindrical projection is only defined for a sphere, GEOTRANS uses an authalic sphere (i.e., a sphere with the same surface area as the ellipsoid associated with the specified datum).

Miller Cylindrical projection coordinates consist of two fields labeled Easting/X and Northing/Y. The legal values for the Easting/X and the Northing/Y fields are optionally signed real values, with up to three decimal places, in meters.

The range of valid Miller Cylindrical easting coordinates depends on the ellipsoid parameters, but is roughly between zero and 20,000,000m from the projection origin. The range of valid Miller Cylindrical northing coordinates depends on the ellipsoid parameters, but is roughly between zero and 14,000,000m from the projection origin.

See Appendix A for more details on Miller Cylindrical projection coordinates.

3.2.2.25 Mollweide Projection

A particular Mollweide projection is defined by the following parameters:

- Central Meridian – A longitude value that specifies the horizontal origin of the projection. Any legal longitude value is valid in this field.
- False Easting – A coordinate value in meters that specifies the Easting/X coordinate at the origin of the projection (i.e., the Central Meridian). Any optionally signed real value, with up to three decimal places, is legal.
- False Northing – A coordinate value in meters that specifies the Northing/Y coordinate at the origin of the projection (i.e., the Origin Latitude). Any optionally signed real value, with up to three decimal places, is legal.

The Origin Latitude of the Mollweide projection is fixed at the Equator.

Because the Mollweide projection is only defined for a sphere, GEOTRANS uses an authalic sphere (i.e., a sphere with the same surface area as the ellipsoid associated with the specified datum).

Mollweide projection coordinates consist of two fields labeled Easting/X and Northing/Y. The legal values for the Easting/X and the Northing/Y fields are optionally signed real values, with up to three decimal places, in meters.

The range of valid Mollweide easting coordinates depends on the ellipsoid parameters, but is roughly between zero and 18,000,000m from the projection origin. The range of valid

Document No. 5034289

Date: 23 October 2012

Mollweide northing coordinates depends on the ellipsoid parameters, but is roughly between zero and 9,000,000m from the projection origin.

See Appendix A for more details on Mollweide projection coordinates.

3.2.2.26 New Zealand Map Grid Projection

There are no parameters.

The New Zealand Map Grid can only be used with the Geodetic Datum 1949 for New Zealand, which uses the International ellipsoid.

New Zealand Map Grid projection coordinates consist of two fields labeled Easting/X and Northing/Y. The legal values for the Easting/X and the Northing/Y fields are optionally signed real values, with up to three decimal places, in meters.

The range of valid latitude values for the New Zealand Map Grid is from 33.5° S to 48.5° S. The range of valid longitude values for the New Zealand Map Grid is from 165.5° E to 180° E.

The range of valid New Zealand Map Grid easting coordinates is from 1,810,000m to 3,170,000m. The range of valid New Zealand Map Grid coordinates is from 5,160,000m to 6,900,000m.

See Appendix A for more details on New Zealand Map Grid projection coordinates.

3.2.2.27 Ney's (Modified Lambert Conformal Conic) Projection

A particular Ney's (Modified Lambert Conformal Conic) projection is defined by the following parameters:

- Central Meridian – A longitude value that specifies the horizontal origin of the projection. Any legal longitude value is valid in this field.
- Origin Latitude – A latitude value that specifies the vertical origin of the projection. Any legal latitude value is valid in this field.
- 1st Standard Parallel – A latitude value that specifies one of the two parallels where the point scale factor is 1.0.
- 2nd Standard Parallel – A latitude value that specifies one of the two parallels where the point scale factor is 1.0.

- False Easting – A coordinate value in meters that specifies the Easting/X coordinate at the origin of the projection (i.e., the Central Meridian). Any optionally signed real value, with up to three decimal places, is legal.
- False Northing – A coordinate value in meters that specifies the Northing/Y coordinate at the origin of the projection (i.e., the Origin Latitude). Any optionally signed real value, with up to three decimal places, is legal.

GEOTRANS limits the Origin Latitude value to between 89 59 59.0° S and 89 59 59.0° N.

The 1st Standard Parallel value is limited to either 71° or 74°. The 2nd Standard Parallel value is fixed at 89° 59' 58.0". The hemisphere of the two Standard Parallels is the same as the hemisphere of the Origin Latitude.

Ney's (Modified Lambert Conformal Conic) projection coordinates consist of two fields labeled Easting/X and Northing/Y. The legal values for the Easting/X and the Northing/Y fields are optionally signed real values, with up to three decimal places, in meters.

The ranges of valid Ney's easting and northing coordinates are between zero and 400,000,000m from the projection origin.

See Appendix A for more details on Ney's (Modified Lambert Conformal Conic) projection coordinates.

3.2.2.28 Oblique Mercator Projection

A particular Oblique Mercator projection is defined by the following parameters:

- Origin Latitude – A latitude value that specifies the vertical origin of the projection. Any legal latitude value is valid in this field.
- Latitude 1 – A latitude value that specifies the latitude of the first point lying on the central line of the projection. The latitude value must be between -90° to +90°, not including the poles.
- Longitude 1 – A longitude value that specifies the longitude of the first point lying on the central line of the projection. Any legal longitude value is valid in this field.
- Latitude 2 – A latitude value that specifies the latitude of the second point lying on the central line of the projection. The latitude value must be between -90° to +90°, not including the poles.

- Longitude 2 – A longitude value that specifies the longitude of the second point lying on the central line of the projection. Any legal longitude value is valid in this field.
- Scale Factor – The ratio between distances in the projection and distances on the surface of the reference ellipsoid. GEOTRANS accepts real scale factor values ranging from 0.3 to 3.0.
- False Easting – A coordinate value in meters that specifies the Easting/X coordinate at the origin of the projection (i.e., the Central Meridian). Any optionally signed real value, with up to three decimal places, is legal.
- False Northing – A coordinate value in meters that specifies the Northing/Y coordinate at the origin of the projection (i.e., the Origin Latitude). Any optionally signed real value, with up to three decimal places, is legal.

GEOTRANS limits the Origin Latitude, Latitude 1, and Latitude 2 values to between 89° S and 89° N.

The two points define the central line of the projection. The latitudes of the two points cannot be the same, but they must both be in the same hemisphere.

Oblique Mercator projection coordinates consist of two fields labeled Easting/X and Northing/Y. The legal values for the Easting/X and the Northing/Y fields are optionally signed real values, with up to three decimal places, in meters.

The ranges of valid Oblique Mercator easting and northing coordinates are between zero and 40,000,000m from the projection origin.

See Appendix A for more details on Oblique Mercator projection coordinates.

3.2.2.29 Orthographic Projection

A particular Orthographic projection is defined by the following parameters:

- Central Meridian – A longitude value that specifies the horizontal origin of the projection. Any legal longitude value is valid in this field.
- Origin Latitude – A latitude value that specifies the vertical origin of the projection. Any legal latitude value is valid in this field. An Origin Latitude value of zero gives the equatorial aspect. An Origin Latitude value of 90 degrees (North or South) gives the polar aspect. Any other Origin Latitude value gives an oblique aspect.

- False Easting – A coordinate value in meters that specifies the Easting/X coordinate at the origin of the projection (i.e., the Central Meridian). Any optionally signed real value, with up to three decimal places, is legal.
- False Northing – A coordinate value in meters that specifies the Northing/Y coordinate at the origin of the projection (i.e., the Origin Latitude). Any optionally signed real value, with up to three decimal places, is legal.

Because the Orthographic projection is only defined for a sphere, GEOTRANS uses an authalic sphere (i.e., a sphere with the same surface area as the ellipsoid associated with the specified datum).

Orthographic projection coordinates consist of two fields labeled Easting/X and Northing/Y. The legal values for the Easting/X and the Northing/Y fields are optionally signed real value, with up to three decimal places, in meters.

GEOTRANS returns an error if the geodetic point being projected is on the opposite side of the Earth from the projection origin.

The range of valid Orthographic easting coordinates depends on the ellipsoid parameters, but is roughly between zero and 6,500,000m from the projection origin. The range of valid Orthographic northing coordinates depends on the ellipsoid parameters, but is roughly between zero and 6,500,000m from the projection origin.

See Appendix A for more details on Orthographic projection coordinates.

3.2.2.30 Polar Stereographic (Standard Parallel) Projections

A particular Polar Stereographic (Standard Parallel) projection is defined by the following parameters:

- Central Meridian – A longitude value that specifies the orientation of the projection. Any legal longitude value is valid in this field.
- Standard Parallel – A latitude value that specifies the parallel where the point scale factor is 1.0. The sign/hemisphere of the specified latitude also determines which pole is at the center of the projection. Any legal latitude value other than zero is valid in this field.
- False Easting – A coordinate value in meters that specifies the Easting/X coordinate at the origin of the projection (i.e., the north or south pole). Any optionally signed real value, with up to three decimal places, is legal.

- False Northing – A coordinate value in meters that specifies the Northing/Y coordinate at the origin of the projection (i.e., the north or south pole). Any optionally signed real value, with up to three decimal places, is legal.

The Central Meridian parameter controls the orientation of the projection, with the specified meridian pointing downward from the pole.

Polar Stereographic coordinates consist of two fields labeled Easting/X and Northing/Y. The legal values for the Easting/X and the Northing/Y fields are optionally signed real values, with up to three decimal places, in meters.

GEOTRANS returns an error if the geodetic point being projected is on the opposite side of the Earth from the pole that is the projection origin.

The ranges of valid Polar Stereographic easting and northing coordinates are between zero and 12,700,000m from the projection origin at the pole.

See Appendix A for more details on Polar Stereographic coordinates.

3.2.2.31 Polar Stereographic (Scale Factor) Projections

A particular Polar Stereographic (Scale Factor) projection is defined by the following parameters:

- Central Meridian – A longitude value that specifies the orientation of the projection. Any legal longitude value is valid in this field.
- Scale Factor – The ratio between distances in the projection and distances on the surface of the reference ellipsoid, at the pole. GEOTRANS accepts scale factor values ranging from 0.3 to 3.0.
- False Easting – A coordinate value in meters that specifies the Easting/X coordinate at the origin of the projection (i.e., the north or south pole). Any optionally signed real value, with up to three decimal places, is legal.
- False Northing – A coordinate value in meters that specifies the Northing/Y coordinate at the origin of the projection (i.e., the north or south pole). Any optionally signed real value, with up to three decimal places, is legal.

The Central Meridian parameter controls the orientation of the projection, with the specified meridian pointing downward from the pole.

Document No. 5034289

Date: 23 October 2012

Polar Stereographic coordinates consist of two fields labeled Easting/X and Northing/Y. The legal values for the Easting/X and the Northing/Y fields are optionally signed real values, with up to three decimal places, in meters.

GEOTRANS returns an error if the geodetic point being projected is on the opposite side of the Earth from the pole that is the projection origin.

The ranges of valid Polar Stereographic easting and northing coordinates are between zero and 12,700,000m from the projection origin at the pole.

See Appendix A for more details on Polar Stereographic coordinates.

3.2.2.32 Polyconic Projection

A particular Polyconic projection is defined by the following parameters:

- Central Meridian – A longitude value that specifies the horizontal origin of the projection. Any legal longitude value is valid in this field.
- Origin Latitude – A latitude value that specifies the vertical origin of the projection. Any legal latitude value is valid in this field.
- False Easting – A coordinate value in meters that specifies the Easting/X coordinate at the origin of the projection (i.e., the Central Meridian). Any optionally signed real value, with up to three decimal places, is legal.
- False Northing – A coordinate value in meters that specifies the Northing/Y coordinate at the origin of the projection (i.e., the Origin Latitude). Any optionally signed real value, with up to three decimal places, is legal.

Polyconic projection coordinates consist of two fields labeled Easting/X and Northing/Y. The legal values for the Easting/X and the Northing/Y fields are optionally signed real values, with up to three decimal places, in meters.

The range of valid Polyconic easting coordinates depends on the ellipsoid parameters, but is roughly between zero and 20,500,000m from the projection origin. The range of valid Polyconic northing coordinates depends on the ellipsoid parameters, but is roughly between zero and 15,500,000m from the projection origin.

GEOTRANS issues a distortion warning for points located more than 90° of longitude from the Central Meridian.

See Appendix A for more details on Polyconic projection coordinates.

3.2.2.33 Sinusoidal Projection

A particular Sinusoidal projection is defined by the following parameters:

- Central Meridian – A longitude value that specifies the horizontal origin of the projection. Any legal longitude value is valid in this field.
- False Easting – A coordinate value in meters that specifies the Easting/X coordinate at the origin of the projection (i.e., the Central Meridian). Any optionally signed real value, with up to three decimal places, is legal.
- False Northing – A coordinate value in meters that specifies the Northing/Y coordinate at the origin of the projection (i.e., the Origin Latitude). Any optionally signed real value, with up to three decimal places, is legal.

The Origin Latitude of the Sinusoidal projection is fixed at the Equator.

Sinusoidal projection coordinates consist of two fields labeled Easting/X and Northing/Y. The legal values for the Easting/X and the Northing/Y fields are optionally signed real values, with up to three decimal places, in meters. The coordinates must designate a point that is located within the boundaries of the specified Sinusoidal projection, which are calculated from the projection parameters.

The range of valid Sinusoidal easting coordinates depends on the ellipsoid parameters, but is roughly between zero and 20,000,000m from the projection origin. The range of valid Sinusoidal northing coordinates depends on the ellipsoid parameters, but is roughly between zero and 10,000,000m from the projection origin.

See Appendix A for more details on Sinusoidal projection coordinates.

3.2.2.34 Stereographic Projection

A particular Stereographic projection is defined by the following parameters:

- Central Meridian – A longitude value that specifies the horizontal origin of the projection. Any legal longitude value is valid in this field.
- Origin Latitude – A latitude value that specifies the vertical origin of the projection. Any legal latitude value is valid in this field. An Origin Latitude value of zero gives the equatorial aspect. An Origin Latitude value of 90 degrees (North or South) gives the polar aspect. Any other Origin Latitude value gives an oblique aspect.

- False Easting – A coordinate value in meters that specifies the Easting/X coordinate at the origin of the projection (i.e., the Central Meridian). Any optionally signed real value, with up to three decimal places, is legal.
- False Northing – A coordinate value in meters that specifies the Northing/Y coordinate at the origin of the projection (i.e., the Origin Latitude). Any optionally signed real value, with up to three decimal places, is legal.

Because the Stereographic projection is only defined for a sphere, GEOTRANS uses an authalic sphere (i.e., a sphere with the same surface area as the ellipsoid associated with the specified datum).

Stereographic projection coordinates consist of two fields labeled Easting/X and Northing/Y. The legal values for the Easting/X and the Northing/Y fields are optionally signed real value, with up to three decimal places, in meters.

The ranges of valid Stereographic easting and northing coordinates depend on the ellipsoid parameters, but are roughly between zero and 1,460,000,000m from the projection origin.

See Appendix A for more details on Stereographic projection coordinates.

3.2.2.35 Transverse Cylindrical Equal Area Projection

A particular Transverse Cylindrical Equal Area projection is defined by the following parameters:

- Central Meridian – A longitude value that specifies the horizontal center of the projection. Any legal longitude value is valid in this field.
- Origin Latitude – A latitude value that specifies the parallel at the vertical center of the projection. Any legal latitude value is valid in this field.
- Scale Factor – The ratio between distances in the projection and distances on the surface of the reference ellipsoid, along the Central Meridian. GEOTRANS accepts scale factor values ranging from 0.3 to 3.0.
- False Easting – A coordinate value in meters that specifies the Easting/X coordinate at the origin of the projection (i.e., the Central Meridian). Any optionally signed real value, with up to three decimal places, is legal.

- False Northing – A coordinate value in meters that specifies the Northing/Y coordinate at the origin of the projection (i.e., the Origin Latitude). Any optionally signed real value, with up to three decimal places, is legal.

Transverse Cylindrical Equal Area projection coordinates consist of two fields labeled Easting/X and Northing/Y. The legal values for the Easting/X and the Northing/Y fields are optionally signed real values, with up to three decimal places, in meters.

The range of valid Transverse Cylindrical Equal Area easting coordinates depends on the ellipsoid parameters, but is roughly between zero and 6,500,000m from the projection origin. The range of valid Transverse Cylindrical Equal Area northing coordinates depends on the ellipsoid parameters, but is roughly between zero and 20,000,000m from the projection origin.

GEOTRANS issues a distortion warning for points located more than 90° of longitude from the Central Meridian.

See Appendix A for more details on Transverse Cylindrical Equal Area projection coordinates.

3.2.2.36 Transverse Mercator Projection

A particular Transverse Mercator projection is defined by the following parameters:

- Central Meridian – A longitude value that specifies the horizontal center of the projection. Any legal longitude value is valid in this field.
- Origin Latitude – A latitude value that specifies the parallel at the vertical center of the projection. Any legal latitude value is valid in this field.
- Scale Factor – The ratio between distances in the projection and distances on the surface of the reference ellipsoid, along the Central Meridian. GEOTRANS accepts scale factor values ranging from 0.3 to 3.0.
- False Easting – A coordinate value in meters that specifies the Easting/X coordinate at the origin of the projection (i.e., the Central Meridian). Any optionally signed real value, with up to three decimal places, is legal.
- False Northing – A coordinate value in meters that specifies the Northing/Y coordinate at the origin of the projection (i.e., the Origin Latitude). Any optionally signed real value, with up to three decimal places, is legal.

Document No. 5034289

Date: 23 October 2012

Transverse Mercator projection coordinates consist of two fields labeled Easting/X and Northing/Y. The legal values for the Easting/X and the Northing/Y fields are optionally signed real values, with up to three decimal places, in meters.

The ranges of valid Transverse Mercator easting and northing coordinates depend on the ellipsoid parameters, but are roughly between zero and 40,000,000m from the projection origin.

GEOTRANS issues a distortion warning for points located more than 9° of longitude from the Central Meridian.

See Appendix A for more details on Transverse Mercator projection coordinates.

3.2.2.37 Van der Grinten Projection

A particular Van der Grinten projection is defined by the following parameters:

- Central Meridian – A longitude value that specifies the horizontal origin of the projection. Any legal longitude value is valid in this field.
- False Easting – A coordinate value in meters that specifies the Easting/X coordinate at the origin of the projection (i.e., the Central Meridian). Any optionally signed real value, with up to three decimal places, is legal.
- False Northing – A coordinate value in meters that specifies the Northing/Y coordinate at the origin of the projection (i.e., the Origin Latitude). Any optionally signed real value, with up to three decimal places, is legal.

The Origin Latitude of the Van der Grinten projection is fixed at the Equator.

Van der Grinten projection coordinates consist of two fields labeled Easting/X and Northing/Y. The legal values for the Easting/X and the Northing/Y fields are optionally signed real values, with up to three decimal places, in meters.

The ranges of valid Van der Grinten easting and northing coordinates depend on the ellipsoid parameters, but are roughly between zero and 20,000,000m from the projection origin.

See Appendix A for more details on Van der Grinten projection coordinates.

3.2.2.38 F-16 Grid Reference System Coordinates

There are no parameters.

F-16 Grid Reference System coordinates are a variation on MGRS coordinates that are intended for compatibility with the navigation system of the F-16 fighter. They consist of a single

alphanumeric string made up of from zero to two digits, followed by three letters, followed by up to ten digits.

See Appendix A for more details on F-16 GRS coordinates.

3.2.3 COORDINATE CONVERSION

Once all of the necessary fields have been filled in, click on one of the Convert buttons to perform the coordinate conversion. The output coordinate fields will change to display the results. The appearance of the output coordinate values are controlled by the current settings of the Geodetic Units, Geodetic Separator, Sign/Hemisphere, Longitude Range, and Precision options, which are discussed in the next section.

3.2.4 ERROR DETECTION AND REPORTING

When you click on one of the Convert buttons, GEOTRANS performs validity checks on both the coordinate reference frame parameters, if any, and the input coordinates. If any of the input parameter or coordinate values is invalid, or the combination of several input parameter or coordinate values is not valid when used together, a message box containing an error message beginning with "Input" and the name of the input coordinate system or map projection is displayed. The remainder of the message identifies the input parameter or coordinate value that is not valid.

If any of the output parameter values is invalid, or the combination of several output parameter values is not valid together, a message box containing an error message beginning with "Output" and the name of the output coordinate system or map projection is displayed. The remainder of the message identifies the output parameter that is invalid.

It may also be the case that the input coordinates are not compatible with the output coordinate system or map projection. For example, if the input coordinates are near the equator, and the output coordinate system is UPS, it will not be possible to convert the coordinates successfully. In such cases, a message box containing an error message beginning with "Output" and the name of the output coordinate system or map projection is displayed. The remainder of the message identifies the coordinate value, usually geodetic latitude, which is invalid.

See the Reference section for a complete list of error message and their explanations.

3.3 OPTIONS

The Options menu provides a mechanism which allows you to control the format in which geodetic coordinates are displayed, and to control the level of precision with which all output

coordinates and projection parameter values are displayed. The Format... option causes a tabbed dialog box to appear. This dialog box has tabs for Number Format and Precision. The Number Format tab provides sets of radio buttons corresponding to the Geodetic Units, Geodetic Separator, Sign/Hemisphere, and Longitude Range options described below. The Precision tab provides a set of radio buttons corresponding to the Precision options described below.

The Options menu also provides a unique Look and Feel option. The Look and Feel of the GUI can be set to Java (default), UNIX (Motif), or Windows. To select a particular Look and Feel option, select the Look and Feel command from the Options menu. A triangle at the right of the menu item indicates that there is a subordinate menu. Drag the cursor to the right, and the submenu will appear. Drag the cursor to the desired option and release the mouse button. The submenu includes an indicator that shows which option is currently selected.

3.3.1 GEODETIC UNITS

The units used to display output latitude and longitude values can be set to degrees/minutes/seconds, degrees/minutes, or degrees.

The setting of this option has no effect on currently displayed latitude and longitude values, only on those values that are subsequently output. Also, the setting of this option does not constrain the format of input latitude or longitude values. Any valid format for input latitude or longitude values can be used at any time.

3.3.2 GEODETIC SEPARATOR

The separator character used when displaying output latitude and longitude values can be set to either blank (i.e., DD MM SS), slash (DD/MM/SS), or colon (DD:MM:SS).

The setting of this option has no effect on currently displayed latitude and longitude values, only on those values that are subsequently output. Also, the setting of this option does not constrain the format of input latitude or longitude values. Any valid format for input latitude or longitude values can be used at any time.

3.3.3 SIGN/HEMISPHERE

The display of output latitude and longitude values can be set to include either an optional preceding sign (+/-) or a following hemisphere indicator (N/S, E/W).

The setting of this option has no effect on currently displayed latitude and longitude values, only on those values that are subsequently output. Also, the setting of this option does not constrain

the format of input latitude or longitude values. Any valid format for input latitude or longitude values can be used at any time.

3.3.4 LONGITUDE RANGE

The range of output longitude values can be set to either -180 to +180, or 0 to 360.

The setting of this option has no effect on currently displayed latitude and longitude values, only on those values that are subsequently output. Also, the setting of this option does not constrain the format of input latitude or longitude values. Any valid format for input latitude or longitude values can be used at any time.

3.3.5 PRECISION

The precision of output coordinates can be set to several different levels:

- 100,000m or 1 degree
- 10,000m or 10 minutes
- 1000m or 1 minute
- 100m or 10 seconds
- 10m or 1 second
- 1m or 0.1 second
- 1m or 0.01 second
- 0.1m or 0.001 second
- 1cm or 0.0001 second
- 1mm or 0.00001 second

Each of the possible precision levels is defined in terms of both a value in meters, for use with Cartesian coordinates and height values, and a value in degrees, minutes, or seconds, for use with geodetic coordinates. All values that are output are rounded to the nearest multiple of the currently selected precision level.

Note that the current setting of the Precision option takes precedence over the current setting of the Geodetic Units option, and may limit the display of the seconds subfield, or of both the minutes and seconds subfields, when the Precision is set to a low level (e.g., 1 degree). When the Units option is set to degrees, the higher precision levels are interpreted so that 1 minute is

considered equivalent to 0.01 degree, and 1 second is considered equivalent to 0.01 minute, or to 0.0001 degree.

In general, the accuracy of the coordinates output by GEOTRANS has only been tested to a level of approximately 1 meter. Thus, accuracy of the additional digits that are displayed when the 0.1m, 1cm, or 1mm precision levels are selected should not be assumed. These high precision output options are intended to support the comparison of outputs from different software packages. For this reason, a warning message is displayed whenever one of these three precision levels is selected.

3.3.6 LEADING ZEROS

This option toggles the display of leading zeros in output geodetic coordinates. When it is selected, leading zeros are displayed in the degree, minute, and second fields of all geodetic coordinates.

3.4 USER-DEFINED DATUMS AND ELLIPSOIDS

The Datum and Ellipsoid menus allow you to create new user-defined datums and ellipsoids. You can also delete any user-defined datums and/or ellipsoids that were created previously. You cannot delete any of the officially supported datums or ellipsoids.

3.4.1 CREATE DATUM

To create a new user-defined datum, select the Create... command from the Datum menu. The Create Datum dialog box appears, as shown in Figure 3-1. Select the 3 Parameter Datum tab to create a 3-Parameter datum, or select the 7 Parameter Datum tab to create a 7-Parameter datum. Enter a three to five character code for the new user-defined datum, and a name for the new user-defined datum in the appropriate fields. Using the pull-down list, select the ellipsoid that is to be associated with the new user-defined datum. Note that if a user-defined ellipsoid is to be associated with a new user-defined datum, that ellipsoid must be created before the datum can be created.

Create Datum

3 Parameter Datum | 7 Parameter Datum

Code: WGE | Name: World Geodetic System 1984

Ellipsoid: WE: WGS 84

Datum Shift to WGS84

Delta X (m): 0 | Delta Y (m): 0 | Delta Z (m): 0

Std. Err in X (m): -1 | Std. Err in Y (m): -1 | Std. Err in Z (m): -1

Valid Domain

Western Longitude: 180 00 00.0W | Northern Latitude: 90 00 00.0N | Eastern Longitude: 180 00 00.0E
Southern Latitude: 90 00 00.0S

OK | Cancel

Create Datum

3 Parameter Datum | 7 Parameter Datum

Code: WGE | Name: World Geodetic System 1984

Ellipsoid: WE: WGS 84

Datum Shift to WGS84

Delta X (m): 0 | Delta Y (m): 0 | Delta Z (m): 0

Rotation X: 0 | Rotation Y: 0 | Rotation Z: 0

Scale: 0

OK | Cancel

Figure 3-1. Create Datum Dialog Box

To create a three parameter datum, enter the datum shift values, which define the transformation from the new user-defined datum to WGS 84, in the X, Y, and Z directions. These are signed integer values, in meters. Enter the associated standard error values, for each axis, in the appropriate fields. These are positive integer values, in meters. A value of -1 indicates that the standard error is unknown.

Enter latitude and longitude values defining the bounding rectangle within which the new user-defined datum is to be considered valid in the appropriate fields. By default, the new datum will be considered valid globally. Any legal latitude and longitude values are valid in these fields.

When all of the necessary values have been entered, click on the OK button. A new user-defined 3-parameter datum will be created. Once the Create Datum dialog box closes, the new user-defined datum will appear at the bottom of both Datum pull-down lists.

To create a seven parameter datum, enter the datum shift values, which define the transformation from the new user-defined datum to WGS 84, in the X, Y, and Z directions. These are signed integer values, in meters. Enter the associated rotation values, for each axis, in the appropriate fields. These range from, -60.0 to 60.0, in arc seconds.

Enter the scale value, which ranges from -0.001 to 0.001, in the appropriate field.

When all of the necessary values have been entered, click on the OK button. A new user-defined 7-parameter datum will be created. Once the Create Datum dialog box closes, the new user-defined datum will appear at the top of both Datum pull-down lists just before the ADI-M datum.

3.4.2 DELETE DATUM

To delete a user-defined datum, select the Delete... command from the Datum menu. The Delete Datum dialog box appears, as shown in Figure 3-2. Select a datum from the drop-down list, and then click on the OK button to delete the datum. The selected datum must be a user-defined datum.

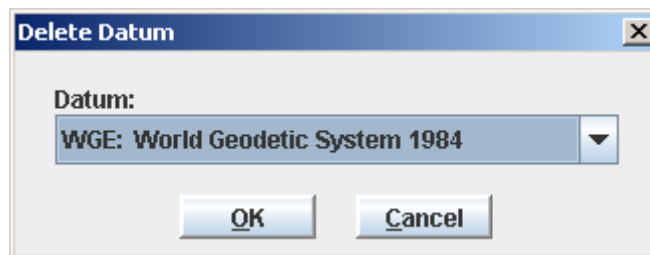

Figure 3-2. Delete Datum Dialog Box

3.4.3 CREATE ELLIPSOID

To define a new user-defined ellipsoid, select the Create... command from the Ellipsoid menu. The Create Ellipsoid dialog box appears, as shown in Figure 3-3. Enter a two-letter code for the new user-defined ellipsoid, a name for the new user-defined ellipsoid, and the semi-major axis and flattening values, in the appropriate fields, then click on the OK button.

The two-letter code for the new ellipsoid cannot be the same as the code for any other ellipsoid. The ellipsoid name may be any string. The flattening value must be between 250 and 350.

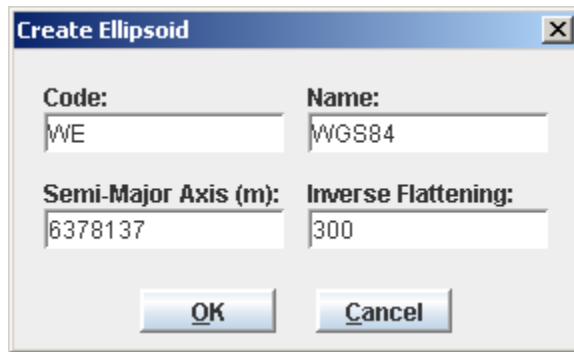

Figure 3-3. Create Ellipsoid Dialog Box

3.4.4 DELETE ELLIPSOID

To delete a user-defined ellipsoid, select the Delete... command from the Ellipsoid menu. The Delete Ellipsoid dialog box appears, as shown in Figure 3-4. Select an ellipsoid from the drop down list, then click on the OK button to delete the ellipsoid. The ellipsoid must be a user-defined ellipsoid and cannot be associated with any user-defined datum.

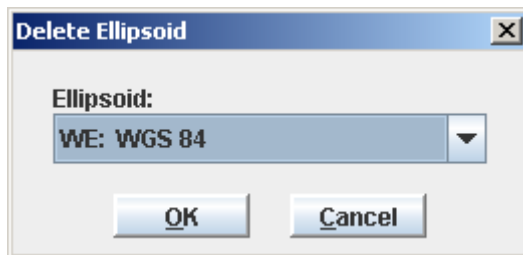

Figure 3-4. Delete Ellipsoid Dialog Box

4. FILE PROCESSING

This section describes how to use the file processing capabilities of the GEOTRANS application. Paragraph 4.1 covers the basics of file processing. Paragraph 4.2 provides additional details on file processing. Paragraph 4.3 discusses the format of GEOTRANS coordinate files.

4.1 BASIC FILE PROCESSING

To process a text file of coordinates, converting them from one coordinate reference frame to another, and/or transforming them from one datum to another, follow these steps:

1. Select the Open... command from the File menu. A standard Open dialog box will appear. The Windows version is shown in Figure 4-1.
2. Use the controls in the File Open dialog box to select an existing text file containing coordinates. The File Open dialog box allows you to move up and down the directory hierarchy, and to filter the list of files displayed. Select the desired file by either double clicking on its name, or by selecting its name and then clicking on the OK button. The GEOTRANS File Processing window will appear, as shown in Figure 4-2. The upper half of the File Processing window displays the input datum, the input coordinate reference frame type, and any associated parameters that were specified in the input file header.
3. If the desired output coordinate reference frame type is not already displayed in the lower half of the window, select the desired entry from the pull-down list in the lower half of the window. The lower half of the window will be updated to display the appropriate parameter fields for the selected output coordinate reference frame type.
4. If the desired output datum, and its associated ellipsoid, are not already displayed in the lower half of the window, select the desired datum using the pull-down list associated with the Datum field near the top of the Output Area.
5. If the output coordinate reference frame type has any parameters associated with it (e.g., a central meridian) and the default parameter values displayed in the lower half of the window are not the desired values, change the parameter values by selecting the displayed values and typing over them.
6. Click on the OK button. A standard Save As... dialog box will appear, with the same layout of fields and controls as the File Open dialog box, as shown in Figure 4-3.

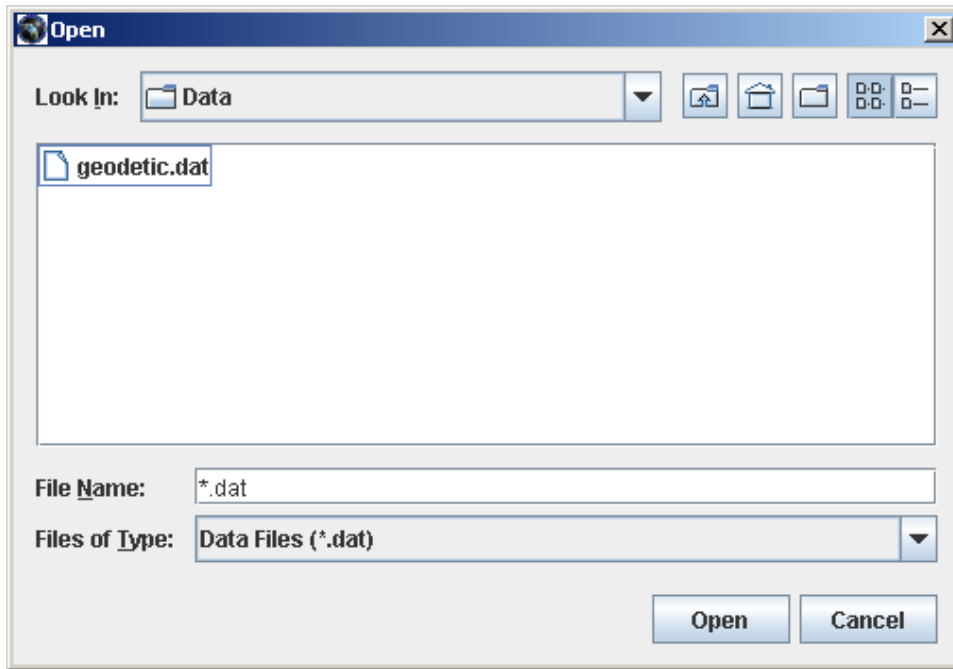

Figure 4-1. File Open Dialog Box (Windows)

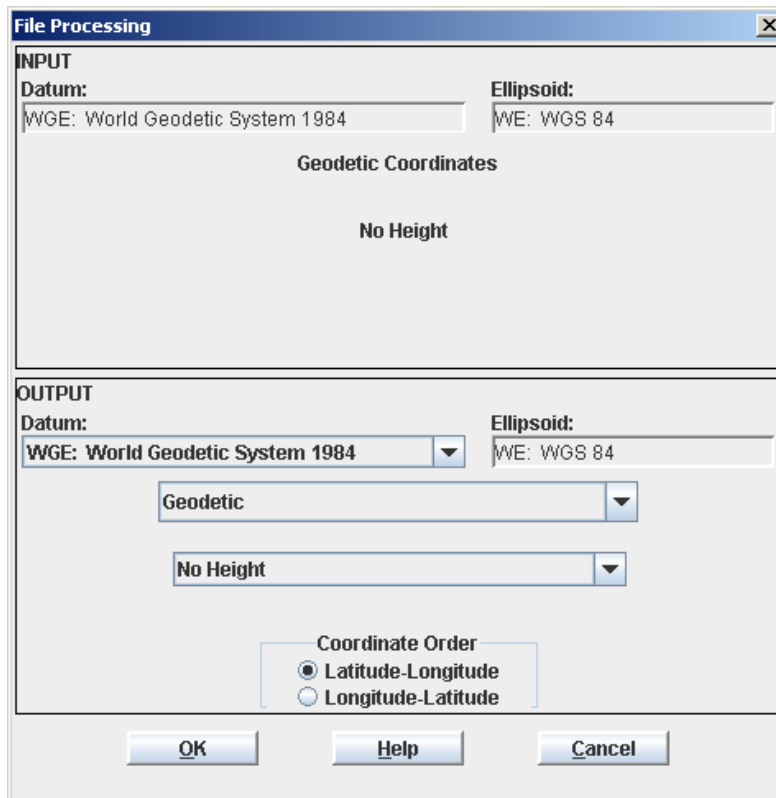

Figure 4-2. GEOTRANS File Processing Window

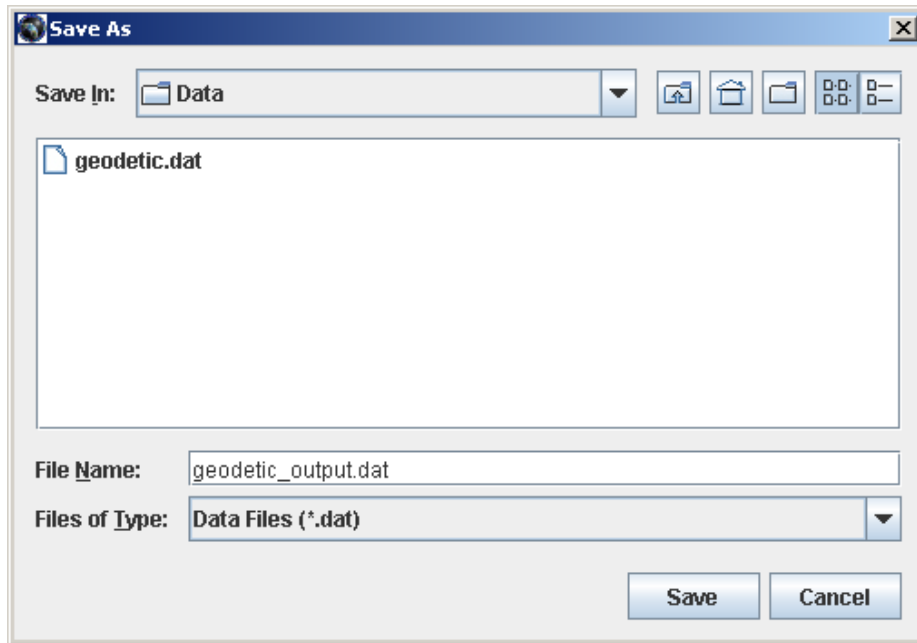

Figure 4-3. Save As Dialog Box (Windows)

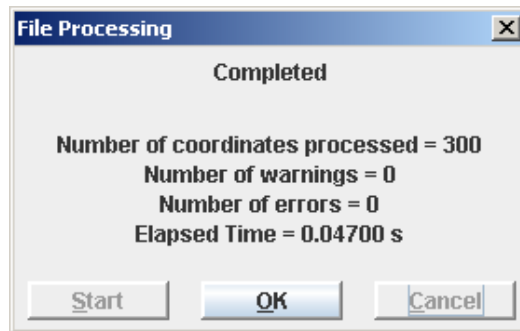

Figure 4-4. GEOTRANS File Processing Dialog Box

7. Use the controls in the Save As dialog box to specify the desired name and location for the output file. Output files should be saved as text files (.txt or .dat). Once the file name has been entered, click on the OK button. A GEOTRANS File Processing dialog box will appear, as shown in Figure 4-4.
8. Click on the Start button to begin file processing, converting the coordinates in the input file and writing the results to the output file. When file processing is completed, a message will be displayed showing the number of coordinate points processed and the number of errors encountered. Click on the OK button to return to the GEOTRANS main window.

The following simple example will illustrate these steps. Given a set of Transverse Mercator coordinates digitized from a map of Korea based on the Tokyo datum, and converted into a GEOTRANS coordinate text file named KOREA.TXT, we want to convert them to Geodetic coordinates based on the WGS 84 datum for use with another system. The above steps would be carried out as follows:

1. Select the Open... command from the File menu. A standard File Open dialog box will appear.
2. Select the name of the file containing the input coordinates, KOREA.DAT, from the scrolling list of files, either by double clicking on the name, or by single clicking on it, then clicking on the OK button. The GEOTRANS File Processing window will appear. The input datum, the input coordinate reference frame type (i.e., Transverse Mercator), and the associated input parameters (Central Meridian, Origin Latitude, Scale Factor, and perhaps False Easting and False Northing) that were specified in the file header are displayed to confirm that the correct file has been selected.
3. Select Geodetic Coordinates from the pull-down list in the lower half of the screen. The lower half of the screen will be updated to show a set of Height Type radio buttons.
4. Since WGS 84 is the default output datum, this step can be skipped.
5. Select one of the Height Type radio buttons. Since the input consists of Transverse Mercator projection coordinates, which are two dimensional, the Height Type selection is automatically set to No Height.
6. Click on the OK button. A standard Save As... dialog box will appear.
7. Enter the desired name for the output file, say KOREAGEO.DAT. Once the file name has been entered, click on the OK button. A GEOTRANS File Processing dialog box will appear.
8. Click on the Start button to begin file processing. When file processing is completed, a message will be displayed showing the number of coordinate points processed and the number of errors detected. Click on the OK button to return to the GEOTRANS main window.

The following sections provide additional information on file processing.

4.2 FILE PROCESSING DETAILS

This section provides some additional details concerning file processing, covering the following topics:

- Input file selection
- Output file content specification
- Output file saving
- File processing
- Error detection and reporting
- Input file header generation

4.2.1 INPUT FILE SELECTION

As described above, file processing is initiated by selecting the Open... command from the File menu. This causes a standard File Open dialog box to appear, as shown in Figure 4-1.

The Windows standard Open dialog box contains a window showing the files and folders in the current directory. Above this window are several controls, including a "Look in:" pull down list that allows you to move to higher levels in the directory hierarchy, a button that allows you to move up one level in the directory hierarchy, a button that allows you to create a new folder, and a pair of buttons that controls the format of the displayed files and folders (List versus Details). Below the window are several more controls, including a "File name:" field that allows you to enter the name of the desired file, a "Files of Type:" pull-down list that allows you to filter the displayed files by type, and Open and Cancel buttons. You can select a file or folder from those displayed in the window by simply clicking on its name or icon. Double clicking on a folder will cause its contents to be displayed in the window. Double clicking on a file both selects and opens it.

Clicking on the OK button causes the currently selected file to be opened. Clicking on the Cancel button aborts file processing and returns you to the interactive mode of GEOTRANS.

The Java standard Open dialog box is essentially identical to the Windows standard Open dialog box.

You can navigate through the directory tree using the scrolling Directories list. This list includes the current directory ('.'), its immediate parent directory ('..'), and any subdirectories contained in the current directory. Clicking on any of these will select that entry, and will update the

contents of the Selection and Filter fields. Double clicking on an entry will move the current directory to that entry.

Similarly, clicking on an entry in the Files list will select that file, and will update the contents of the Selection field. Double clicking on an entry will cause that file to be opened.

If desired, the path and file name of the desired input file can be entered directly into the Selection field. Typing return will cause the OK button to be activated.

Clicking on the OK button will cause the currently selected file to be opened. Clicking on the Filter button will cause the Files list to be filtered according to the contents of the Filter field. The Cancel button will cause the File Open dialog box to close and return GEOTRANS to its normal interactive mode. The Help button will activate the on-line help subsystem.

4.2.2 OUTPUT FILE CONTENT SPECIFICATION

Once the input file has been opened, the GEOTRANS File Processing window appears as shown in Figure 4-2. In the upper half of this window, the input datum, the input coordinate reference frame type, and any associated parameters that were specified in the input file header are displayed. You cannot change any of these entries.

In the lower half of the window, the output datum, the output coordinate reference frame type, and any associated parameters are displayed. Initially, these fields will all contain default values.

To set the datum for the output file, click on the Datum pull-down list button to cause the list of available datums to appear. Scroll through the list until the entry for the desired datum is visible, then click on it to select it and close the list.

To set the coordinate reference frame type for the output file, click on the currently displayed value to cause a pop-up menu of coordinate reference frame types to appear, and then select the desired entry. The display will update to show the appropriate parameter fields for the selected coordinate reference frame type. Initially, these fields will contain default values.

Set the values of any parameters by selecting the individual fields and typing in the desired values, in exactly the same way as for interactive coordinate conversion.

The formats of any geodetic coordinates that are written to the output file, either in the file header or in the file body, and the precision of the output coordinates written to the output file, are determined by the current settings in the Options menu. These should be set to the desired choices before file processing is initiated.

When finished, click on the OK button to proceed. Clicking on the Cancel button aborts file processing and returns GEOTRANS to interactive mode.

4.2.3 OUTPUT FILE SAVING

Clicking the OK button in the File Processing window causes a standard File Save As dialog box to appear, as shown in Figure 4-3. Output files should be saved as text (.txt or .dat) files.

The Windows standard Save As dialog box is identical in layout to the Windows Open dialog box. You can enter the output file name directly into the "File name:" field or you can select the output file from those displayed in the window above it. Clicking on an entry selects the file, updating the "File name:" field, while double clicking saves the output file using the selected name. The "Look in:" pulldown list can be used to move upward in the directory hierarchy. The pull-down list labeled "Files of type:" allows you to filter the displayed file list according to the choices provided.

Clicking on the OK button causes the output file to be created using the currently selected file name and folder. Clicking on the Cancel button aborts file processing and returns you to the interactive mode of GEOTRANS.

The Java standard Save As dialog box is essentially identical to the Windows standard Save As dialog box.

Clicking on the OK button will cause the output file to be created with the currently selected path and file name. Clicking on the Filter button will cause the Files list to be filtered according to the contents of the Filter field. The Cancel button will cause the Save As dialog box to close and return GEOTRANS to its normal interactive mode. The Help button will activate the on-line help subsystem.

4.2.4 FILE PROCESSING

Saving the output file causes the output file header to be written, and the GEOTRANS File Processing dialog box to appear. This dialog box consists of a message area and a row of three buttons at the bottom. The Start button, which is initially enabled, causes GEOTRANS to begin processing the coordinates in the input file and writing the results to the output file. The message in the dialog box changes to indicate that processing is in progress. When file processing is completed, the message in the dialog box again changes to indicate this, as well as the number of coordinates processed, and the number of errors detected, and the OK button is enabled. Clicking on the OK button returns GEOTRANS to the interactive mode.

Clicking on the Cancel button instead of the Start button will abort file processing and return GEOTRANS to the interactive mode.

4.2.5 ERROR DETECTION AND REPORTING

There are several different categories of errors that can be detected and reported during file processing. For a comprehensive list of error messages and their explanations, see paragraph 5.3.

Syntax errors encountered while reading the input file header, such as misspelled keywords, or badly formed projection parameter values, are reported immediately after the input file is opened using message boxes. When these error messages are acknowledged, file processing is aborted. The file header must be corrected before the file can be processed.

After the File Processing window appears, displaying the input datum, coordinate reference frame, and any parameter values read from the input file, the parameter values are checked for validity relative to the specified input coordinate reference frame. Any errors detected are immediately reported using message boxes. When these error messages are acknowledged, file processing is aborted. The parameter values must be corrected before the file can be processed.

As you enter any required output parameters, basic checking is performed on these values. In general, GEOTRANS will not allow an illegal value to be entered, beeping whenever a bad character is typed, and rejecting that character.

If the specified output parameter values are legal, they are checked for validity relative to the specified output coordinate reference frame. Any errors detected are immediately reported using message boxes. Once these error messages are acknowledged, control returns to the File Processing window so that the invalid parameter values can be corrected.

Once the processing of the coordinates contained in the file begins, errors detected in reading the input coordinates, and errors resulting from the incompatibility of the input coordinates with the output coordinate system or map projection, are both reported by writing error messages in the output file, in the form of comments, so that each line in the input file corresponds to a single line in the output file. The final File Processing window reports the number of such errors encountered when file processing is completed. To eliminate these errors, the input file must be corrected.

4.2.6 INPUT FILE HEADER GENERATION

Although the GEOTRANS coordinate file format is very simple, creating the header for an input coordinate file manually can be an error prone process. To automate this, you can use the Create File Header command, which is located in the File menu, as follows:

1. Select the Create File Header command from the File menu. The Create File Header window will appear.
2. In the Create File Header window, specify the datum, the coordinate reference system type, and any associated parameters for the input coordinate file that you desire. Then click the Create button, which will cause a standard file Save As dialog box to appear.
3. In the Save As dialog box, specify a file name and directory for the resulting coordinate file header. Click on the Save button to cause the file to be created, and return to the GEOTRANS main window.

The resulting file will contain the specified header information. This header can then be attached to an existing text file of coordinates to create a GEOTRANS input coordinate file.

4.3 GEOTRANS COORDINATE FILE FORMAT

A GEOTRANS coordinate file consists of multiple sections. Each section consists of a header that specifies the coordinate system type and datum of the input coordinates, along with any required parameter values, followed by a sequence of input coordinate lines, with one set of coordinate values per line, with the individual coordinate values separated by commas, each followed by at least one space.

The following example shows a GEOTRANS coordinate file containing Mercator projection coordinates defined relative to the WGS 84 datum. The file header defines the coordinate reference frame type, the datum, ellipsoid, and the projection parameters, which for a Mercator projection include the Central Meridian, the Latitude of True Scale, the False Easting, and the False Northing.

Example:

```
COORDINATES: Mercator
DATUM: WGE
#ELLIPSOID: WE
CENTRAL MERIDIAN: 0 0 0.00E
LATITUDE OF TRUE SCALE: 0 0 0.00N
FALSE EASTING: 0
FALSE NORTHING: 0
END OF HEADER
-503297, 4056709
 490031, 4872921
```

Document No. 5034289

Date: 23 October 2012

331276, 5139284
 221385, 5582934
 113908, 5932832
 -123456, 6123233

4.3.1 COORDINATE FILE HEADER

The header of a GEOTRANS coordinate file consists of two or more header lines, each containing a keyword or phrase which identifies the purpose of the line, followed by a colon ":", followed by a value. The list of supported keywords and phrases can be found in the GEOTRANS on-line help, under "File Processing."

The coordinate system type for the input coordinates in the file is specified using either of the keywords COORDINATES or PROJECTION. The datum for the input coordinates in the file is specified using the keyword DATUM. Additional header lines are used to specify any additional required parameter values. The order of the header lines is arbitrary, but parameters are interpreted with respect to the most recent previously specified coordinate system type. If the same parameter keyword or phrase appears more than once, the new value replaces the earlier specified value. The header is terminated by a line containing the phrase END OF HEADER.

If any required characteristic or parameter value is not specified in the input coordinate file header, a default value is assigned. The default coordinate system type is Geodetic, and the default datum is WGE (WGS 84). For each coordinate system type, the default parameter values used are the same as the default values that are displayed in the parameter fields in the GEOTRANS main window when that coordinate system type is first selected.

Additional "headers" can be included within the body of a GEOTRANS coordinate file to change the coordinate system, datum, and/or parameter values. The start of each additional header is indicated by a line containing the keyword HEADER. This is followed by a sequence of header lines terminated by a line containing the phrase END OF HEADER.

The header of a GEOTRANS coordinate file consists of two or more lines, each containing a key word or phrase which identifies the purpose of the line, followed by a colon ":", followed by a value. The key words and phrases that can be included in a GEOTRANS coordinate file header are:

- **COORDINATES** or **PROJECTION** – This line identifies the coordinate reference frame type of the coordinates in the file. Therefore, a line with one of these two key words should be included in every GEOTRANS coordinate file header, and should precede any lines which set map projection parameters. The associated value consists of a word or phrase identifying the coordinate system or map projection, as follows:

Document No. 5034289

Date: 23 October 2012

- Geodetic
 - GEOREF
 - GARS
 - Geocentric
 - Local Cartesian
 - MGRS
 - USNG
 - UTM
 - UPS
 - Albers Equal Area Conic
 - Azimuthal Equidistant
 - Bonne
 - British National Grid
 - Cassini
 - Cylindrical Equal Area
 - Eckert IV
 - Eckert VI
 - Equidistant Cylindrical
 - Gnomonic
 - Lambert Conformal Conic (1 Standard Parallel)
 - Lambert Conformal Conic (2 Standard Parallel)
 - Mercator, which defaults to Mercator (Standard Parallel)
 - Mercator (Standard Parallel)
 - Mercator (Scale Factor)
 - Miller Cylindrical
 - Mollweide
 - New Zealand Map Grid
 - Ney's (Modified Lambert Conformal Conic)
 - Oblique Mercator
 - Orthographic
 - Polar Stereographic, which defaults to Polar Stereographic (Standard Parallel)
 - Polar Stereographic (Standard Parallel)
 - Polar Stereographic (Scale Factor)
 - Polyconic
 - Sinusoidal
 - Stereographic
 - Transverse Cylindrical Equal Area
 - Transverse Mercator
 - Van der Grinten
- DATUM – This line identifies the datum for which the coordinates in the file are defined. A line with this key word should be included in every GEOTRANS coordinate file

header. The associated value consists of a standard 3-letter or 5-letter datum code, as defined in the datum pull-down lists in the GEOTRANS main and file processing windows (e.g., WGE, EUR-M, EAS, etc.).

- ELLIPSOID – This line is optional and only used as a comment. It identifies the ellipsoid associated with the current datum. The value consists of a standard 2-letter ellipsoid code (e.g., WE, IN, etc.).
- COORDINATE ORDER – This line specifies the ordering of the geodetic coordinates in the file. The value is either LATITUDE-LONGITUDE or LONGITUDE-LATITUDE. The default is LATITUDE-LONGITUDE.
- ELLIPSOID HEIGHT – This line specifies that any height values in Geodetic input coordinates are measured relative to the selected ellipsoid surface. A line with this key word is optional in a GEOTRANS input file header, and applies only to geodetic input coordinates. If it is not included, all geodetic height values default to ellipsoid heights. The GEOTRANS output file header will contain this line if the Ellipsoid Height type has been specified with Geodetic coordinates.
- MSL-EGM2008-2.5M-BCS HEIGHT – This line specifies that any height values in Geodetic input coordinates are measured relative to the EGM2008 geoid model (if the corresponding datum is WGS84) or mean sea level (MSL) surface (otherwise) using a 2.5-minute grid and bicubic spline interpolation. A line with this key word must be included in the GEOTRANS input file header if MSL-EGM2008-2.5M-BCS height values are to be input. If it is not included, all geodetic height values default to ellipsoid heights. The GEOTRANS output file header will contain this line if the MSL-EGM2008-2.5M-BCS Height type has been specified with Geodetic coordinates.
- MSL-EGM96-15M-BL HEIGHT– This line specifies that any height values in Geodetic input coordinates are measured relative to the EGM96 geoid model (if the corresponding datum is WGS84) or mean sea level (MSL) surface (otherwise) using a 15-minute grid and bilinear interpolation. A line with this key word must be included in the GEOTRANS input file header if MSL-EGM96-15M-BL height values are to be input. If it is not included, all geodetic height values default to ellipsoid heights. The GEOTRANS output file header will contain this line if the MSL-EGM96-15M-BL Height type has been specified with Geodetic coordinates.
- MSL-EGM96-VG-NS HEIGHT – This line specifies that any height values in Geodetic input coordinates are measured relative to the EGM96 geoid model (if the corresponding

datum is WGS84) or mean sea level (MSL) surface (otherwise), using a variable resolution grid and natural spline interpolation. This model is included for compatibility with older systems. A line with this key word must be included in the GEOTRANS input file header if MSL-EGM96-VG-NS height values are to be input. If it is not included, all geodetic height values default to ellipsoid heights. The GEOTRANS output file header will contain this line if the MSL-EGM96-VG-NS Height type has been specified with Geodetic coordinates.

- MSL-EGM84-10D-BL HEIGHT – This line specifies that any height values in Geodetic input coordinates are measured relative to the EGM84 geoid model (if the corresponding datum is WGS84) or mean sea level (MSL) surface (otherwise), using a 10-degree grid and bilinear interpolation. This model is included for compatibility with older systems. A line with this key word must be included in the GEOTRANS input file header if MSL-EGM84-10D-BL height values are to be input. If it is not included, all geodetic height values default to ellipsoid heights. The GEOTRANS output file header will contain this line if the MSL-EGM84-10D-BL Height type has been specified with Geodetic coordinates.
- MSL-EGM84-10D-NS HEIGHT – This line specifies that any height values in Geodetic input coordinates are measured relative to the EGM84 geoid model (if the corresponding datum is WGS84) or mean sea level (MSL) surface (otherwise), using a 10-degree grid and natural spline interpolation. This model is included for compatibility with older systems. A line with this key word must be included in the GEOTRANS input file header if MSL-EGM84-10D-NS height values are to be input. If it is not included, all geodetic height values default to ellipsoid heights. The GEOTRANS output file header will contain this line if the MSL-EGM84-10D-NS Height type has been specified with Geodetic coordinates.
- MSL-EGM84-30M-BL HEIGHT – This line specifies that any height values in Geodetic input coordinates are measured relative to the EGM84 geoid model (if the corresponding datum is WGS84) or mean sea level (MSL) surface (otherwise), using a 30-minute grid and bilinear interpolation. This model is included for compatibility with older systems and is more accurate than the MSL-EGM84-10D-BL HEIGHT. A line with this key word must be included in the GEOTRANS input file header if MSL-EGM84-30M-BL height values are to be input. If it is not included, all geodetic height values default to ellipsoid heights. The GEOTRANS output file header will contain this line if the MSL-EGM84-30M-BL Height type has been specified with Geodetic coordinates.

- NO HEIGHT – This line specifies that no height values are included with input Geodetic coordinates. A line with this key word must be included in a GEOTRANS input file header if geodetic height values are not to be input. If it is not included, all geodetic height values default to ellipsoid heights. The GEOTRANS output file header will contain this line if the No Height type has been specified with Geodetic coordinates.
- CENTRAL MERIDIAN – This line specifies the value of a Central Meridian parameter, which defines the horizontal center of a map projection. It is used by all of the map projections (Albers Equal Area Conic, Azimuthal Equidistant, Bonne, Cassini, Cylindrical Equal Area, Eckert IV, Eckert VI, Equidistant Cylindrical, Gnomonic, Lambert Conformal Conic (1 Standard Parallel), Lambert Conformal Conic (2 Standard Parallel), Mercator, Miller Cylindrical, Mollweide, Ney's (Modified Lambert Conformal Conic), Orthographic, Polyconic, Sinusoidal, Stereographic, Transverse Cylindrical Equal Area, Transverse Mercator, and Van der Grinten) except British National Grid, New Zealand Map Grid, Polar Stereographic and Oblique Mercator. The associated value is a longitude value in degrees, degrees/minutes, or degrees/minutes/seconds, and defaults to 0°E.
- ORIGIN LATITUDE – This line specifies the value of an Origin Latitude parameter, which defines the vertical center of a map projection. It is used by most of the map projections (Albers Equal Area Conic, Azimuthal Equidistant, Bonne, Cassini, Cylindrical Equal Area, Gnomonic, Lambert Conformal Conic (1 Standard Parallel), Lambert Conformal Conic (2 parallel), Ney's (Modified Lambert Conformal Conic), Oblique Mercator, Orthographic, Polyconic, Stereographic, Transverse Cylindrical Equal Area, and Transverse Mercator). It is also used, along with the Origin Longitude, and Origin Height parameters, to specify the location of the origin of a Local Cartesian coordinate system. The associated value is a latitude value in degrees, degrees/minutes, or degrees/minutes/seconds, and defaults to 0N.
- STANDARD PARALLEL – This line specifies the value of a Standard Parallel parameter, which defines a parallel along which the point scale factor of the projection is 1.0. It is used by the Equidistant Cylindrical, Mercator (Standard Parallel), and Polar Stereographic (Standard Parallel) projections. The associated value is a latitude value in degrees, degrees/minutes, or degrees/minutes/seconds, and defaults to 0°N.
- STANDARD PARALLEL ONE – This line specifies the value of a Standard Parallel parameter, which defines a parallel along which the point scale factor of the projection is 1.0. It is used by the Albers Equal Area Conic, Lambert Conformal Conic (2 Standard

Parallel) and Ney's (Modified Lambert Conformal Conic) projections. The associated value is a latitude value in degrees, degrees/minutes, or degrees/minutes/seconds, and defaults to 45°N for Albers and Lambert and 71°N for Ney's.

- **STANDARD PARALLEL TWO** – This line also specifies the value of a Standard Parallel parameter. It is used by the Albers Equal Area Conic and Lambert Conformal Conic (2 Standard Parallel) projections. It may be used by the Ney's (Modified Lambert Conformal Conic) projection, but only as a comment. The associated value is a latitude value in degrees, degrees/minutes, or degrees/minutes/seconds, and defaults to 50°N for Albers and Lambert and 89 59 59.0°N for Ney's.
- **LATITUDE ONE** – This line specifies the value of a first latitude parameter, which defines the latitude of the first point lying on the central line. It is used by the Oblique Mercator projection. The associated value is a latitude value in degrees, degrees/minutes, or degrees/minutes/seconds, and defaults to 40°N.
- **LONGITUDE ONE** – This line specifies the value of a first longitude parameter, which defines the longitude of the first point lying on the central line. It is used by the Oblique Mercator projection. The associated value is a longitude value in degrees, degrees/minutes, or degrees/minutes/seconds, and defaults to 5°W.
- **LATITUDE TWO** – This line specifies the value of a second latitude parameter, which defines the latitude of the second point lying on the central line. It is used by the Oblique Mercator projection. The associated value is a latitude value in degrees, degrees/minutes, or degrees/minutes/seconds, and defaults to 50°N.
- **LONGITUDE TWO** – This line specifies the value of a second longitude parameter, which defines the longitude of the second point lying on the central line. It is used by the Oblique Mercator projection. The associated value is a longitude value in degrees, degrees/minutes, or degrees/minutes/seconds, and defaults to 5°E.
- **SCALE FACTOR** – This line specifies the projection Scale Factor parameter, which defines the ratio between distances measured in the projection coordinate space, and the corresponding distances on the surface of the reference ellipsoid. It is used by the Lambert Conformal Conic (1 Standard Parallel), Mercator (Scale Factor), Oblique Mercator, Polar Stereographic (Scale Factor), Transverse Cylindrical Equal Area and Transverse Mercator projections. The associated value consists of a real number between 0.3 and 3.0. The default value is 1.0.

- FALSE EASTING – This line specifies the Easting, or X, coordinate at the origin of the projection. It offsets the projection coordinates, and is commonly used to avoid the need for negative coordinates by setting the coordinate at the origin to a relatively high value. It is used by all of the map projections. The associated value is an optionally signed integer in meters, and defaults to zero.
- FALSE NORTHING – This line specifies the Northing, or Y, coordinate at the origin of the projection. It offsets the projection coordinates, and is commonly used to avoid the need for negative coordinates by setting the coordinate at the origin to a relatively high value. It is used by all of the map projections. The associated value is an optionally signed integer in meters, and defaults to zero.
- ORIGIN LONGITUDE – This line specifies the value of an Origin Longitude parameter, which, with the Origin Latitude and Origin Height parameters, specifies the location of the origin of a Local Cartesian coordinate system. The associated value is a longitude value in degrees, degrees/minutes, or degrees/minutes/seconds, and defaults to 0°E.
- ORIGIN HEIGHT – This line specifies the value of an Origin Height parameter, which, with the Origin Latitude and Origin Longitude parameters, specifies the location of the origin of a Local Cartesian coordinate system. The associated value is a height value in meters relative to the ellipsoid surface, and defaults to zero.
- ORIENTATION – This line specifies the value of an Orientation parameter, which specifies the angle from north to the positive Y axis of a Local Cartesian coordinate system. The associated value is a longitude value in degrees, degrees/minutes, or degrees/minutes/seconds, and defaults to 0°.
- HEMISPHERE – This line specifies the hemisphere for a Polar Stereographic (Scale Factor) projection. The valid values are “N” for the northern hemisphere, or “S” for the southern hemisphere. The default is the southern hemisphere.
- LONGITUDE DOWN FROM POLE – This line specifies the orientation of a Polar Stereographic projection. The specified longitude defines the direction of the negative Y axis of the resulting projection. The associated value is a longitude value in degrees, degrees/minutes, or degrees/minutes/seconds, and defaults to 0°.
- LATITUDE OF TRUE SCALE – This line specifies the scale of a Mercator or Polar Stereographic projection, in terms of the latitude at which the scale factor has a value of 1.0. The associated value is a latitude value in degrees, degrees/minutes, or degrees/minutes/seconds, and defaults to 90°N.

4.3.2 COORDINATE FILE BODY

Following the header, the body of a GEOTRANS coordinate file consists of one or more coordinate lines, with each line containing a single set of coordinate values. A coordinate line consists of individual coordinate values separated by commas, each followed by at least one space. Additional spaces may be used for readability, such as to align columns of coordinate values. Input coordinates can take on several different forms, depending on the nature of the coordinate system or map projection being used, including:

- Geodetic Coordinates: Latitude, Longitude, and optionally Height, in any of the format variations supported by the GEOTRANS GUI.
- Geocentric and Local Cartesian Coordinates: X, Y, and Z, in meters.
- Map projection coordinates: Easting and Northing, in meters.
- British National Grid, GEOREF, GARS, MGRS, and USNG Coordinate Strings: alphanumeric strings that conform to the syntax of each of these systems.
- UTM Coordinates: Zone (1 to 60), Hemisphere ('N' or 'S'), Easting, and Northing, in meters.
- UPS Coordinates: Hemisphere ('N' or 'S'), X, and Y, in meters.

In all cases, the coordinate value formats that may be used in a GEOTRANS coordinate file are exactly the same as the format that may be used when entering coordinates into GEOTRANS interactively.

If a third (i.e., height) coordinate is included with a pair of map projection coordinates in an input coordinate file, it will be passed through unchanged to the output coordinate file.

4.3.3 COMMENTS AND BLANK LINES

Comments can be included in a GEOTRANS coordinate file. Comments have no reliable internal structure; they are solely intended to convey additional information to human readers.

A comment line is indicated by a "#" as the first character. Comment lines that appear in a header are not echoed to the output file, as they are assumed to contain information that depends on the input coordinate reference system defined by that header. Comment lines that appear in the coordinate file body are echoed to the output file.

Trailing comments can be included in both the header and the body, with the exception of the COORDINATES line. A trailing comment is indicated by a "#" character within the line; all text

Document No. 5034289

Date: 23 October 2012

on the line following the "#" character is considered to be a comment. Trailing comments are not echoed to the output file.

Blank lines can also be included in either the header or the body. Blank lines in the body are echoed to the output file, but blank lines in the header are not.

4.3.4 OUTPUT FILES

The coordinate files created by GEOTRANS are identical in format to the coordinate files that it reads. Thus, any coordinate file created by GEOTRANS may be subsequently used as an input coordinate file. The header of the output file is generated based on the output datum and coordinate reference frame type selections made in the GEOTRANS File Processing window. The number of lines in the output file header may not be identical to the number of lines in the input file header, especially if the number of parameters is different. Any comment lines in the input file header are not copied to the output file header.

Following the file header, one line in the output file is generated for each line in the input file. For each line in the input file containing coordinates, a line is written to the output file containing the corresponding converted coordinates. Conversion accuracy information, in the form of 90% circular error (CE), linear error (LE), and spherical error (SE) values, in meters, is appended to each output line in the form of a comment. If an error is encountered in converting the coordinates on a particular line, a comment line is written to the output file containing the appropriate error message. If a warning is encountered in converting the coordinates on a particular line, a comment line is written to the output file containing the appropriate warning message. The converted coordinates are then written on the next line. Any comment lines in the body of the input file are copied unchanged to the output file. Any blank lines in the body of the input file are also copied to the output file.

There is no standard naming convention for GEOTRANS coordinate files. Typically, file extensions such as ".TXT", or ".DAT" are used.

5. REFERENCE

This section provides reference information on the following topics:

- The windows and dialog boxes that make up the GEOTRANS graphical user interface, including the main window and the file processing windows (paragraph 5.1).
- The menu bar, and the fields and controls that are used to specify datums, coordinate reference frames, parameters, and coordinates (paragraph 5.2).
- The error conditions that may be reported by GEOTRANS (paragraph 5.3).
- The on-line help subsystem (paragraph 5.4).

5.1 WINDOWS & DIALOG BOXES

This paragraph describes the windows and dialog boxes that make up the GEOTRANS graphical user interface. Paragraph 5.1.1 describes the main window, while paragraph 5.1.2 describes the windows and dialog boxes that support file processing. Paragraph 5.1.3 describes the Create Datum, Delete Datum, Create Ellipsoid, and Delete Datum dialog boxes.

5.1.1 MAIN WINDOW

As shown in Figure 5-1, the GEOTRANS main window consists of the following elements, from top to bottom:

- Title Bar, which includes the standard Windows or Java window controls.
- Menu Bar, which contains the following pull-down menus: File, Edit (Java only), Options, Datum, Ellipsoid, Convert, and Help.
- Upper area, which contains the following subelements:
 - Datum pull-down list, which displays the code and name of the currently selected datum, and which you can use to select a different datum.
 - Ellipsoid field, which displays the code and name of the reference ellipsoid associated with the currently selected datum.
 - Pull-down list that displays the name of the currently selected coordinate reference frame, and which you can use to select a different coordinate reference frame.
 - Set of zero or more parameter fields and/or controls for the currently selected coordinate reference frame type.

MSP GEOTRANS 3.2

File Edit Options Datum Ellipsoid Convert Help

Geodetic

No Height

Longitude: 0 0 0.0E Latitude: 0 0 0.0N Height (m): 0

90% CE: Unk 90% LE: N/A 90% SE: N/A Sources: Unknown

Convert Upper -> Lower Convert Lower -> Upper

Universal Transverse Mercator (UTM)

Zone (1-60): 0 Hemisphere: N S

Override: Easting / X (m): 500000 Northing / Y (m): 0

90% CE: Unk 90% LE: N/A 90% SE: N/A Sources: Unknown

Figure 5-1. GEOTRANS Main Window

- Set of coordinate fields and/or controls for the currently selected coordinate reference frame type, which you can use to specify coordinate values that are to be converted.
- Standard error fields, in which input coordinate accuracy values can be entered, and which display output coordinate accuracy values for the most recent conversion.

There are three fields. The 90% circular error (CE), in meters, estimates the horizontal accuracy of the output coordinates. The 90% linear error (LE), in meters, estimates the vertical accuracy of geodetic heights. The 90% spherical error (SE), in meters, estimates the three-dimensional accuracy of geocentric and local Cartesian coordinates.

- Source pull-down menu, which displays the names of possible sources for input sources. These include GPS coordinates, various types of hardcopy maps, and various types of digital geospatial data. Selecting one of these entries causes all three of the standard error fields to be set to values appropriate for the selected source.
- Two Convert buttons, Convert (Upper-to-Lower) and Convert (Lower-to-Upper), which, when clicked, causes the coordinates specified in one area (upper or lower) to be converted to the datum and coordinate reference frame specified in the other area (lower or upper) and causes the resulting coordinate values to be displayed in the coordinate fields of the other area. The Convert buttons are color-coded as follows:
 - Red indicates that one of the selected coordinate reference frames is incompatible with the corresponding datum selection, and therefore any attempted conversion operation will result in an error. Typically, this occurs when the current coordinate reference (e.g., British National Grid) is only compatible with datums that use a specific ellipsoid (e.g., Airy).
 - Yellow indicates that the valid regions for the two selected datums are disjoint from one another, and therefore any attempted conversion operation will result in a warning. Typically, this occurs when two local datums for different parts of the world (e.g., Europe and North America) are selected.
 - Green indicates that the current coordinate reference frame and datum selections are compatible with one another.
- Lower area, which contains the same types of subelements as the upper area.
- Optional Status Bar (Windows only) which displays the purpose of the currently selected menu item.

Normally, the upper area is used to specify the input datum, coordinate reference frame type, parameters, and coordinates, while the lower area is used to specify the output datum, coordinate reference frame type, and parameters, and to display the output coordinates. However, the roles of input and output areas are completely flexible. Which area is which is determined only when one of the Convert buttons is clicked on.

The commands and options contained in the Menu Bar are described in paragraph 5.2.1. The various types of fields and controls that can appear in the upper and lower areas, depending on the currently selected input and output coordinate reference frame type, are each described in paragraph 5.2.2.

5.1.2 FILE PROCESSING WINDOWS & DIALOG BOXES

There are several windows and dialog boxes that are associated with GEOTRANS coordinate file processing. These include:

- GEOTRANS File Open dialog box, which is either a standard Windows Open dialog box, or a standard Java Open dialog box.
- GEOTRANS File Processing window, which is used to display the datum, coordinate reference frame type, and associated parameters, if any, of the selected input coordinate file, and to specify the datum, coordinate reference frame type, and associated parameters, if any, of the output coordinate file that is to be created.
- GEOTRANS Save As dialog box, which is either a standard Windows Save As dialog box, or a standard Java Save As dialog box.
- GEOTRANS File Processing dialog box, which is used to display the progress of file processing.

Each of these windows is described in the paragraphs below.

5.1.2.1 File Open Dialog Box

The Windows version of the GEOTRANS File Open dialog box is a standard Windows Open dialog box, as shown in Figure 5-2. This dialog box contains the following elements:

- "Look in:" pull down list that allows you to move to higher levels in the directory hierarchy.
- A button that allows you to move up one level in the directory hierarchy.
- A button that allows you to create a new folder.
- A pair of buttons that controls the format of the displayed files and folders (List vs. Details).
- A window showing the files and folders that are contained within the current folder, which you can use to select the file to be opened.

- A "File name:" field, in which you can enter the name of the file to be opened.
- A "Files of Type:" pull-down list that allows you to filter the displayed files by their type.
- An Open button, which causes the currently selected file to be opened, and the GEOTRANS File Processing window to appear.
- A Cancel button, which aborts file processing and returns you to the GEOTRANS main window.

The Java version of the GEOTRANS File Open dialog box is a standard Java Open dialog box. Its layout and functionality are essentially identical to the standard Windows Open dialog box.

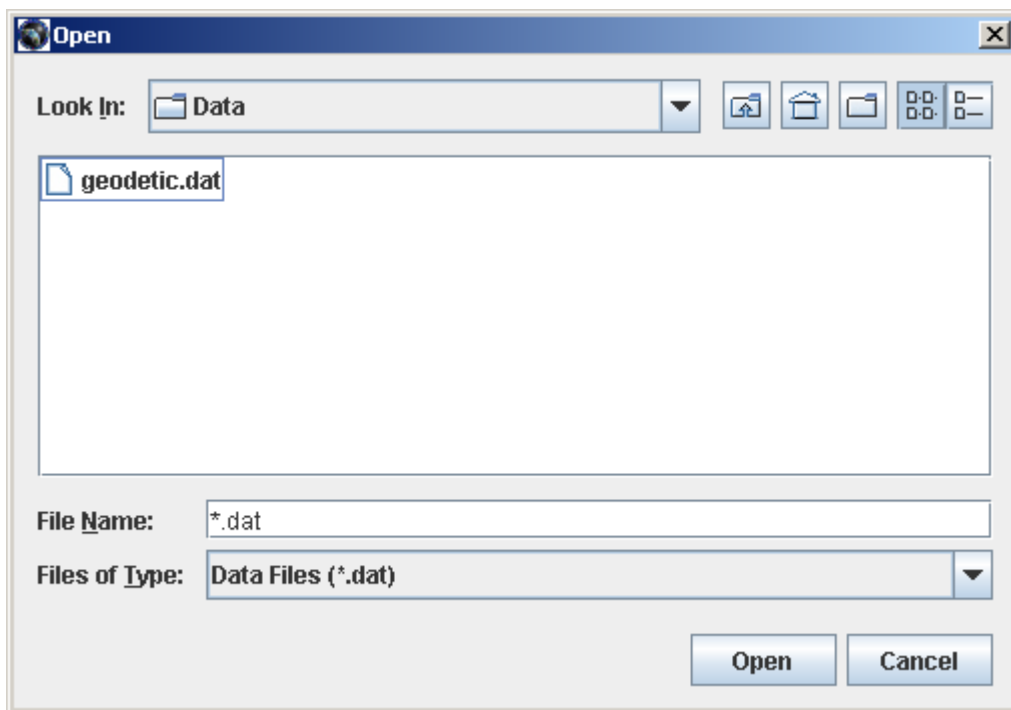

Figure 5-2. File Open Dialog Box (Windows)

5.1.2.2 File Processing Window

The Windows version of the GEOTRANS File Processing window is shown in Figure 5-3. The GEOTRANS File Processing window consists of the following elements, from top to bottom:

- Title Bar, which includes the standard Windows window controls.
- Upper area, which is very similar to the upper area of the GEOTRANS main window, consisting of the following subelements:

- Datum field which displays the code and name of the input datum specified in the input coordinate file.
 - Ellipsoid field, which displays the code and name of the reference ellipsoid associated with the input datum specified in the input coordinate file.
 - The name of the input coordinate reference frame type specified in the current input coordinate file.
 - A set of parameter fields and/or controls for the current input coordinate reference frame type, if it has any parameters, which display the parameter values specified in the current input coordinate file.
- Lower area, which is very similar to the lower area of the GEOTRANS main window, in which you specify the characteristics of the output coordinate file that is to be created, consisting of the following subelements:
 - Datum pull-down list, which displays the code and name of the currently selected output datum, and which you can use to select a different output datum.

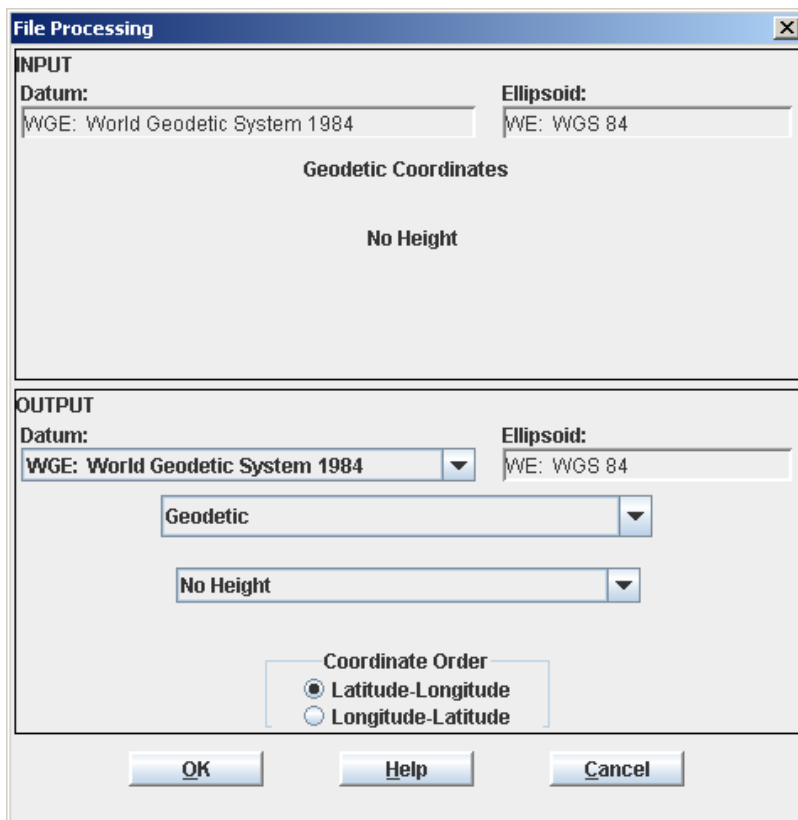

Figure 5-3. GEOTRANS File Processing Window

- Ellipsoid field, which displays the code and name of the reference ellipsoid associated with the currently selected output datum.
- Pop-up menu of coordinate reference frame types, containing the same entries as the pop-up menus in the main window, which you can use to specify the coordinate reference frame type of the output coordinate file.
- A set of parameter fields for the currently selected output coordinate reference frame type, if it has any parameters, which you can use to specify the parameter values that are to be used in the output coordinate file.
- A row of three buttons across the bottom:
 - OK – which causes the output parameters to be evaluated and the Save As dialog box to appear.
 - Help – which activates the on-line help subsystem.
 - Cancel – which aborts file processing and returns you to the GEOTRANS main window.

5.1.2.3 Save As Dialog Box

The Windows versions of the GEOTRANS Save As dialog box contains the same elements as the Windows Open dialog box, but is used to specify the name and location of the output coordinate file that is to be created.

The Java version of the GEOTRANS Save As dialog box is a standard Java Save As dialog box. Its layout and functionality are essentially identical to the standard Windows Save As dialog box.

5.1.2.4 File Processing Dialog Box

The GEOTRANS File Processing dialog box, shown in Figure 5-4, consists of a title bar, a message area, and a row of three buttons across the bottom:

- Start – which you use to start the processing of the input coordinate file and the creation of the output coordinate file.
- OK – which you use to confirm the completion of the file processing.
- Cancel – which you can use to cancel file processing before it is performed.

Initially, the Start and Cancel buttons are enabled. Once the Start button is clicked, it is not possible to interrupt file processing. However, file processing is quite rapid, achieving a speed on the order of one thousand coordinates per second on a mid-range Pentium PC. When file

processing is complete, the number of coordinate sets processed, and the number of errors detected, are displayed in the message area, and the OK button is enabled.

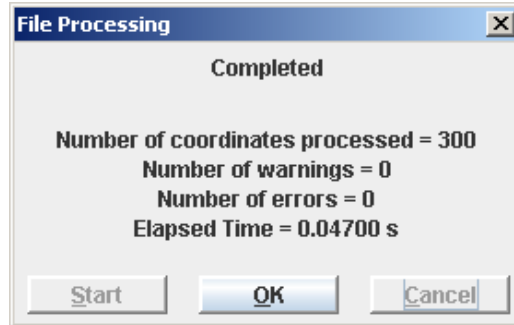

Figure 5-4. GEOTRANS File Processing Dialog Box

5.1.2.5 Create File Header Window

The Create File Header window, shown in Figure 5-5, consists of the following elements, from top to bottom:

- Title Bar, which includes the standard window Close control.
- Input area, which is very similar to both the upper and lower areas of the GEOTRANS main window, in which you specify the characteristics of the coordinate file header that is to be created, consisting of the following sub-elements:
 - Datum pull-down list, which displays the code and name of the currently selected datum, and which you can use to select a different datum.
 - Ellipsoid field, which displays the code and name of the reference ellipsoid associated with the currently selected datum.
 - A pop-up menu of coordinate reference frame types, containing the same entries as the pop-up menus in the main window, which you can use to specify the coordinate reference frame type to be used in the coordinate file header that is to be created.
 - A set of parameter fields for the currently selected coordinate reference frame type, if it has any parameters, which you can use to specify the parameter values that are to be used in the coordinate file header that is to be created.
 - When the selected coordinate reference frame type is Geodetic, a Coordinate Order box containing a pair of radio buttons, which you can use to specify the order of the

geodetic coordinates (Latitude-Longitude or Longitude-Latitude) in the coordinate file header that is to be created.

- A row of two buttons across the bottom:
 - Create – which causes a standard file Save As dialog box to appear.
 - Cancel – which aborts coordinate file header creation, and returns you to GEOTRANS the main window.

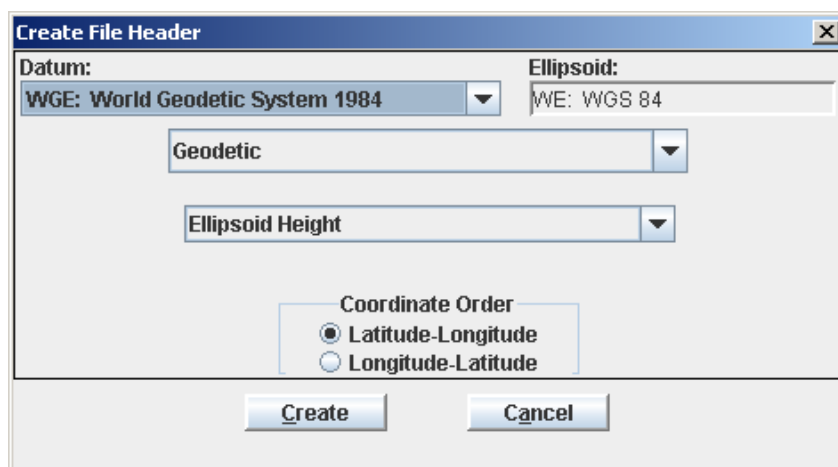

Figure 5-5. Create File Header Window

5.1.3 CREATE ELLIPSOID & CREATE DATUM DIALOG BOXES

This paragraph describes the dialog boxes that are used to create and delete user-defined datums and ellipsoids.

5.1.3.1 Create Datum Dialog Box

The Windows version of the Create Datum dialog box is shown in Figure 5-6. The Create Datum dialog box 3-Parameter tab contains the following subelements:

- Code field, in which you specify a new three- to five-letter code for the new user-defined datum. This code cannot be the same as any code that is already used for another datum.
- Name field, in which you specify a name for the new user-defined datum. The name may be any string.
- Ellipsoid pull-down list, with which you specify the ellipsoid that is to be associated with the new user-defined datum.

- Delta X, Delta Y, and Delta Z fields, in which you specify the datum shift values from the new user-defined datum to WGS 84. The shift values are optionally signed real values, in meters.
- Standard Error in X, Standard Error in Y, and Standard Error in Z fields, in which you specify the standard error for each of the datum shift values. The standard errors are positive real values, in meters. However, if the standard error is unknown, a value of negative one (-1) should be entered.
- A set of four fields in which you specify the valid domain of the new user-defined datum. The Western Longitude and Eastern Longitude values may be any valid longitude values. However, the Western Longitude value must be to the west of the Eastern Longitude value. The Northern Latitude and Southern Latitude values may be any valid latitude values. However, the Southern Latitude value must be to the south of the Northern Latitude value.

The Create Datum dialog box 7-Parameter tab contains the following subelements:

- Code field, in which you specify a new three- to five-letter code for the new user-defined datum. This code cannot be the same as any code that is already used for another datum.
- Name field, in which you specify a name for the new user-defined datum. The name may be any string.
- Ellipsoid pull-down list, with which you specify the ellipsoid that is to be associated with the new user-defined datum.
- Delta X, Delta Y, and Delta Z fields, in which you specify the datum shift values from the new user-defined datum to WGS 84. The shift values are optionally signed real values, in meters.
- Rotation X, Rotation Y, and Rotation Z fields, in which you specify the datum rotation values from the new user-defined datum to WGS 84. The rotation values range from -60.0 to 60.0, in arc seconds.
- Scale field, in which you specify the scale factor value from the new user-defined datum to WGS 84. The scale value ranges from -0.001 to 0.001.

The Create Datum dialog box also contains the following subelements:

- Cancel button – which aborts datum creation and returns you to the GEOTRANS main window.

- OK button – which causes a new user-defined datum to be created using the specified parameter values.

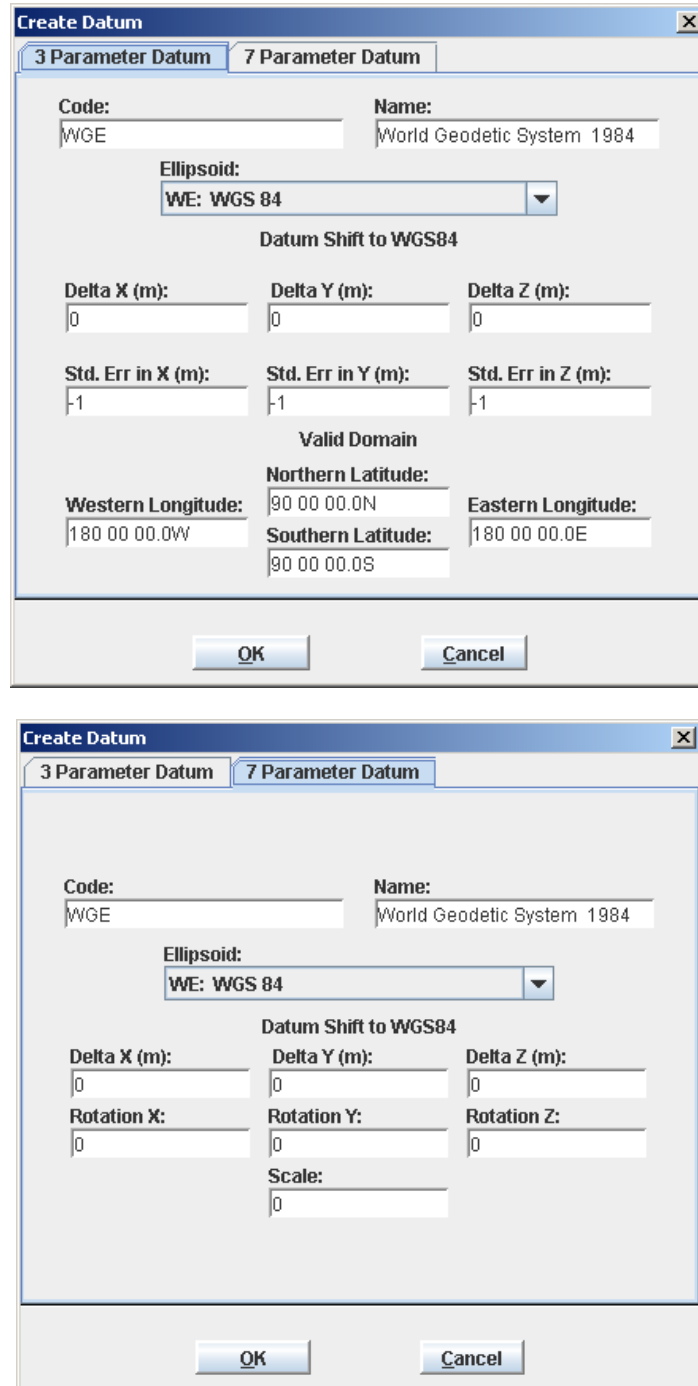

Figure 5-6. Create Datum Dialog Box

5.1.3.2 Delete Datum Dialog Box

The Windows version of the Delete Datum dialog box is shown in Figure 5-7. The Delete Datum dialog box contains the following subelements:

- Datum pull-down list, with which you specify the user-defined datum that is to be deleted.
- Cancel button – which aborts datum deletion and returns you to the GEOTRANS main window.
- OK button – which causes the specified user-defined datum to be deleted.

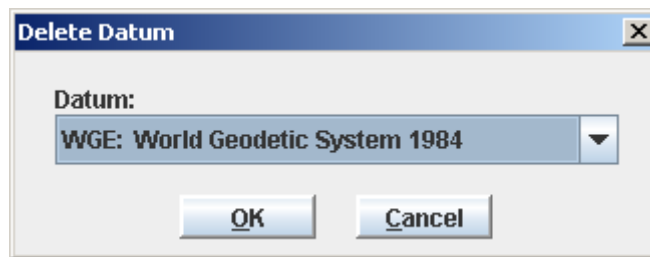

Figure 5-7. Delete Datum Dialog Box

5.1.3.3 Create Ellipsoid Dialog Box

The Windows version of the Create Ellipsoid dialog box is shown in Figure 5-8. The Create Ellipsoid dialog box contains the following subelements:

- Code field, in which you specify a new two-letter code for the new user-defined ellipsoid. This code cannot be the same as any code that is already used for another ellipsoid.
- Name field, in which you specify a name for the new user-defined ellipsoid. The name may be any string.
- Semi-Major Axis field, in which you specify the semi-major axis length for the new user-defined ellipsoid, as a positive integer value in meters.
- Flattening field, in which you specify the flattening for the new user-defined ellipsoid, as a positive integer value between 250 and 350.
- Cancel button – which aborts ellipsoid creation and returns you to the GEOTRANS main window.
- OK button – which causes a new user-defined ellipsoid to be created using the specified parameter values.

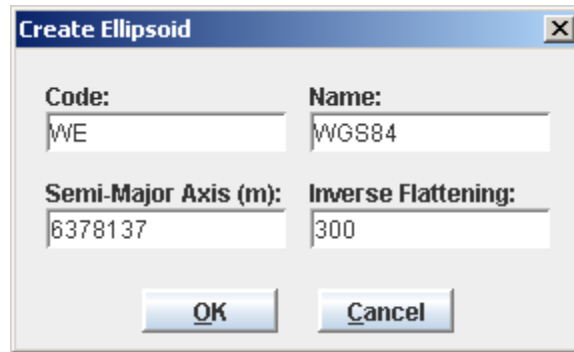

Figure 5-8. Create Ellipsoid Dialog Box

5.1.3.4 Delete Ellipsoid Dialog Box

The Windows version of the Delete Ellipsoid dialog box is shown in Figure 5-9. The Delete Ellipsoid dialog box contains the following subelements:

- Ellipsoid pull-down list, with which you specify the user-defined ellipsoid that is to be deleted.
- Cancel button – which aborts ellipsoid deletion and returns you to the GEOTRANS main window.
- OK button – which causes the specified user-defined ellipsoid to be deleted.

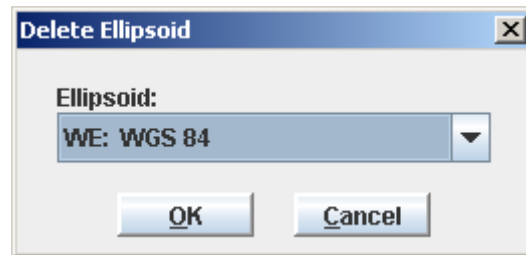

Figure 5-9. Delete Ellipsoid Dialog Box

5.2 MENUS, FIELDS, & CONTROLS

This paragraph describes the commands and options contained in the menu bar of the main window, and each of the fields and other controls contained in the main and File Processing windows that are used to specify datums, coordinate reference frames, associated parameters, and coordinates.

5.2.1 MENU BAR

The GEOTRANS menu bar contains seven pull-down menus:

- **File** menu, which contains commands for file processing and for exiting the program.
- **Edit** menu, which provides standard Cut, Copy, and Paste commands.
- **Options** menu, which provides various options that allow you to control the format and precision of output coordinate values.
- **Datum** menu, which allows you to create and delete user-defined datums.
- **Ellipsoid** menu, which allows you to create and delete user-defined ellipsoids.
- **Convert** menu, which allows you to convert coordinates.
- **Help** menu, which provides access to the on-line help subsystem.

This paragraph describes the contents of each of these menus.

5.2.1.1 File Menu

The File menu contains commands which allow you to process text files containing large numbers of coordinates, or to exit the program.

Open...

The Open command allows you to select a text file containing coordinates to be processed. It begins the file processing dialog by bringing up a standard File Open dialog box that you can use to select the file to be read. For more information, see Section 4, which describes File Processing, or paragraph 5.1.2, which describes the File Processing user interface.

Create File Header...

The Create File Header command allows you to create a GEOTRANS coordinate file header for a specified datum and coordinate reference system, along with any associated parameters. It begins the input file header generation dialog by bringing up the Create File Header window, which is identical to the lower half of the File Processing window.

Load Settings

The Load Settings command allows you to set the current format options, input and output datum selections, input and output coordinate reference system selections, and any

associated parameter values, to the settings previously stored in the settings file, which is located in the data directory.

Save Settings

The Save Settings command allows you to save the current format options, input and output datum selections, input and output coordinate reference system selections, and any associated parameter values, to the settings file, which is located in the data directory.

Exit

The Exit command immediately terminates the GEOTRANS program, causing the GEOTRANS window to disappear.

5.2.1.2 Edit Menu

The Edit menu contains the standard Cut, Copy, and Paste commands.

5.2.1.3 Options Menu

The Options menu contains commands that allow you to control the format and precision in which output coordinate values are displayed. Newly selected options take effect when one of the Convert buttons is clicked, or when one of the coordinate reference frame selections is changed.

Geodetic Units

The Geodetic Units command provides a submenu of options that allow you to control the angular units in which output geodetic coordinates are displayed. The format in which geodetic coordinates are displayed is also affected by the setting of the Precision option. For example, if the Geodetic Units option is set to Degrees/Minutes/Seconds, but the Precision option is set to 1 minute, no second's subfield will be displayed. Geodetic coordinates may be input using any variation, or combination of variations, of the supported formats.

Degrees/Minutes/Seconds

This option causes output geodetic coordinates to be displayed in degrees, minutes, and seconds format (i.e., DDD MM SS.FF).

Degrees/Minutes

This option causes output geodetic coordinates to be displayed in degrees and minutes format (i.e., DDD MM.FFFF).

Degrees

This option causes output geodetic coordinates to be displayed in decimal degrees format (i.e., DDD.FFFFFFF).

Separator

The Separator command provides a submenu of options that allow you to control the character used to separate the degree, minutes, and seconds subfields when output geodetic coordinates are displayed.

DD MM SS

This option causes the degrees, minutes, and seconds subfields of output geodetic coordinates to be separated by a blank space (' ').

DD/MM/SS

This option causes the degrees, minutes, and seconds subfields of output geodetic coordinates to be separated with a slash ('/').

DD:MM:SS

This option causes the degrees, minutes, and seconds subfields of output geodetic coordinates to be separated with a colon (':').

Sign / Hemisphere

The Sign / Hemisphere command provides a submenu of options that allow you to control the way in which the sign or hemisphere of output geodetic coordinates is displayed.

+/-

This option causes output geodetic coordinates to be displayed with a minus sign ('-') as a prefix when their values are negative. No sign is displayed when their values are positive.

N/S, E/W

This option causes output geodetic coordinates to be displayed with a hemisphere letter ('N' or 'S' for latitude, 'E' or 'W' for longitude) as a suffix.

Longitude Range

The Longitude Range command provides a submenu of options that allow you to control the range in which output geodetic longitudes are displayed.

-180 to +180

This option causes output geodetic longitudes to be displayed in the range from -180 degrees to +180 degrees.

0 to 360

This option causes output geodetic longitudes to be displayed in the range from 0 degrees to 360 degrees.

Precision

The Precision command provides a submenu of options that allow you to control the precision with which output coordinates are displayed, ranging from 1 meter (or .01 second) to 100,000 meters (or 1 degree). GEOREF, MGRS, and USNG coordinates are truncated, while all other coordinate values are rounded. To remain in the starting grid square UTM & UPS coordinates are truncated prior to conversion to MGRS or USNG. In general, you should use the Precision option that matches the precision or accuracy of your input data, whichever is worse. If no Precision option exactly matches this value, use the next better precision. For example, if your source data looks like "20 55 44.22N, 55 55 42.86E", with an average error of 0.2 seconds, use the 0.1 second Precision option. If your data looks like "20 55N, 55 55E", and is accurate to one minute, use the 1 minute Precision option.

100,000m or 1 degree

This option causes output coordinates to be displayed rounded (or truncated) to the nearest 100,000 meters (for Easting/X, Northing/Y, Z, and Height values) or to the nearest 1 degree (for Latitude and Longitude values).

10,000m or 10 minutes

This option causes output coordinates to be displayed rounded (or truncated) to the nearest 10,000 meters (for Easting/X, Northing/Y, Z, and Height values) or to the nearest 10 minutes (for Latitude and Longitude values).

1000m or 1 minute

This option causes output coordinates to be displayed rounded (or truncated) to the nearest 1,000 meters (for Easting/X, Northing/Y, Z, and Height values) or to the nearest 1 minute (for Latitude and Longitude values).

100m or 10 seconds

This option causes output coordinates to be displayed rounded (or truncated) to the nearest 100 meters (for Easting/X, Northing/Y, Z, and Height values) or to the nearest 10 seconds, 0.1 minutes, or 0.001 degrees, as appropriate (for Latitude and Longitude values).

10m or 1 second

This option causes output coordinates to be displayed rounded (or truncated) to the nearest 10 meters (for Easting/X, Northing/Y, Z, and Height values) or to the nearest 1 second, 0.01 minutes, or 0.0001 degrees, as appropriate (for Latitude and Longitude values).

1m or 0.1 second

This option causes output coordinates to be displayed rounded (or truncated) to the nearest 1 meter (for Easting/X, Northing/Y, Z, and Height values) or to the nearest 0.1 second, 0.001 minutes, or 0.00001 degrees, as appropriate (for Latitude and Longitude values).

0.1m or 0.01 second

This option causes output coordinates to be displayed rounded (or truncated) to the nearest 0.1 meter (for Easting/X, Northing/Y, Z, and Height values) or to the nearest 0.01 second, 0.0001 minutes, or 0.000001 degrees, as appropriate (for Latitude and Longitude values). A warning is displayed whenever this precision level is selected, because GEOTRANS has not been tested to the level of accuracy that the additional displayed digits imply.

1cm or 0.001 second

This option causes output coordinates to be displayed rounded (or truncated) to the nearest 0.01 meter (for Easting/X, Northing/Y, Z, and Height values) or to the nearest 0.001 second, 0.00001 minutes, or 0.0000001 degrees, as appropriate (for Latitude and Longitude values). A warning is displayed whenever this precision level is selected, because GEOTRANS has not been tested to the level of accuracy that the additional displayed digits imply.

1mm or 0.0001 second

This option causes output coordinates to be displayed rounded (or truncated) to the nearest 0.001 meter (for Easting/X, Northing/Y, Z, and Height values) or to the nearest 0.0001 second, 0.000001 minutes, or 0.00000001 degrees, as appropriate (for Latitude and Longitude values). A warning is displayed whenever this precision level is selected, because GEOTRANS has not been tested to the level of accuracy that the additional displayed digits imply.

Leading Zeros

This option toggles the display of leading zeros in output geodetic coordinates. When it is selected, leading zeros are displayed in the degree, minute, and second fields of all geodetic coordinates.

Format... (Java only)

The Format... command causes a tabbed dialog box to appear. This dialog box has tabs for Number Format and Precision. The Number Format tab provides sets of radio buttons corresponding to the Geodetic Units, Geodetic Separator, Sign/Hemisphere, and Longitude Range options described above. The Precision tab provides a set of radio buttons corresponding to the Precision options described above.

Look and Feel (Java only)

The Look and Feel command provides a submenu of options, which allow you to control the general appearance of the GEOTRANS GUI.

Java (default)

This option causes the GUI to have the default Java look and feel.

Unix

This option causes the GUI to have the look and feel of a Motif user interface.

Windows

This option causes the GUI to have the look and feel of a Windows user interface.

Color (Windows only)

The Color command provides a submenu of commands, which allow you to customize the background and text colors of the GEOTRANS window.

Background (Windows only)

The Background command allows you to customize the background color of the GEOTRANS window. It brings up a standard Windows color selection dialog box.

Text (Windows only)

The Text command allows you to customize the color of the text within the GEOTRANS window. It brings up a standard Windows color selection dialog box.

Status Bar (Windows only)

The Status Bar command allows you to show or hide the status bar at the bottom of the GEOTRANS window, which provides a short description of each low-level menu item whenever it is selected using the cursor.

5.2.1.3 Datum Menu

The Datum menu contains commands, which allow you to create and delete user-defined datums.

Create...

The Create Datum command allows you to create a new user-defined 3-parameter or 7-parameter datum. It opens the Create Datum dialog box where you can specify the code, name, and parameters for a new user-defined datum. For more information, see paragraph 3.4.1, which describes how to create a user-defined datum, or paragraph 5.1.3.1, which describes the Create Datum dialog box.

Delete...

The Delete Datum command allows you to delete a previously created user-defined datum. It opens the Delete Datum dialog box where you can select the user-defined datum to be deleted. For more information, see paragraph 3.4.2, which describes how to delete a user-defined datum, or paragraph 5.1.3.2, which describes the Delete Datum dialog box.

5.2.1.4 Ellipsoid Menu

The Ellipsoid menu contains commands, which allow you to create and delete user-defined ellipsoids.

Create...

The Create Ellipsoid command allows you to create a new user-defined ellipsoid. It opens the Create Ellipsoid dialog box where you can specify the code, name, and parameters for a new user-defined ellipsoid. For more information, see paragraph 3.4.3, which describes how to create a user-defined ellipsoid, or paragraph 5.1.3.3, which describes the Create Ellipsoid dialog box.

Delete...

The Delete Ellipsoid command allows you to delete a previously created user-defined ellipsoid. It opens the Delete Ellipsoid dialog box where you can select the user-defined ellipsoid to be deleted. For more information, see paragraph 3.4.4, which describes how to delete a user-defined ellipsoid, or paragraph 5.1.3.4, which describes the Delete Ellipsoid dialog box.

5.2.1.5 Convert Menu

The Convert menu contains commands, which allow you to convert coordinates.

Upper to Lower

The Convert Upper to Lower command allows you to convert the coordinates in the upper half of the window to the coordinate reference frame specified in the lower half of the window, outputting the results to the lower coordinate fields. Its effect is exactly the same as that of the Convert: Upper to Lower button.

Lower to Upper

The Convert Lower to Upper command allows you to convert the coordinates in the lower half of the window to the coordinate reference frame specified in the upper half of the window, outputting the results to the upper coordinate fields. Its effect is exactly the same as that of the Convert: Lower to Upper button.

5.2.1.6 Help Menu

The Help menu contains commands, which provide you with additional information about the GEOTRANS program and its operation.

Contents

The Contents command allows you to access to the on-line help subsystem.

About...

The About command provides you with a brief description of the GEOTRANS application.

5.2.2 FIELDS AND CONTROLS

This paragraph describes each of the different types of data entry and/or display fields and controls that may appear within the GEOTRANS main window. Section 3 specifies which of these are associated with each of the supported coordinate reference frames.

90%CE:

The 90% circular error (CE), in meters, estimates the horizontal accuracy of coordinates. Values can be entered directly into this field to indicate the accuracy of the input coordinates. Values can also be entered into this field by selecting a coordinate source from the Sources pull-down menu. When a conversion is performed, this field displays the accuracy of the output coordinates.

90%LE:

The 90% linear error (LE), in meters, estimates the vertical accuracy of geodetic heights. Values can be entered directly into this field to indicate the accuracy of the input coordinates. Values can also be entered into this field by selecting a coordinate source from the Sources pull-down menu. When a conversion is performed, this field displays the accuracy of the output coordinates.

90%SE:

The 90% spherical error (SE), in meters, estimates the three-dimensional accuracy of geocentric and local Cartesian coordinates. Values can be entered directly into this field to indicate the accuracy of the input coordinates. Values can also be entered into this field by selecting a coordinate source from the Sources pull-down menu. When a conversion is performed, this field displays the accuracy of the output coordinates.

British National Grid Coordinate String:

This field is used to enter or display a British National Grid coordinate string. A British National Grid coordinate string is an alphanumeric string consisting of two letters, followed by a sequence of up to ten digits.

A British Grid is divided into twenty five 500,000 unit squares. Each square is identified by an alphabetic letter. Letters are arranged alphabetically left to right, top to bottom. The letter I is

Document No. 5034289

Date: 23 October 2012

omitted. Each 500,000 unit square is divided into twenty five 100,000 unit squares. Each 100,000 unit square is also identified by a letter. Letters of the 100,000 unit squares are arranged the same as the 500,000 unit squares. The first letter of a British National Grid coordinate string represents the 500,000 unit square and the second letter represents the 100,000 unit square.

The remainder of the British National Grid coordinate string consists of the numeric Easting and Northing values within the 100,000-meter grid square. The left half of the digit sequence is the Easting value, which is read to the right from the left edge of the 100,000-meter grid square. The right half of the digit sequence is the Northing value, which is read northward from the bottom edge of the 100,000-meter grid square. Both the Easting and Northing values are within the range from 0 to 100,000 meters. Both Easting and Northing values must have the same resolution and must include leading zeros. It is desirable to leave a space between the letters and numbers.

Examples:

SJ 1108977917 (1m resolution)

SJ 111779 (100m resolution)

SJ 18 (10,000m resolution)

Central Meridian:

This field is used to enter or display the Central Meridian parameter of a particular projection. The Central Meridian is the longitude value at the horizontal center of a projection, sometimes also known as the Origin Longitude. See **Longitude** for the details of the format of the values that can be entered in this field.

Coordinate Reference Frame:

This pull-down list displays the name of the currently selected input or output coordinate reference frame. It also allows you to change the current input or output coordinate reference frame selection. Click on the arrow to cause the scrolling list of supported datums to appear, scroll up or down until the desired entry is visible, and click on the entry to select it.

This pull-down list also appears in the lower area of the GEOTRANS File Processing window, where it displays the currently selected output coordinate reference frame that will be used for file processing, and can be used, as described above, to change that selection.

Document No. 5034289

Date: 23 October 2012

Datum:

This pull-down list displays the code and name of the currently selected input or output datum. It also allows you to change the current input or output datum selection. Click on the arrow to cause the scrolling list of supported datums to appear, scroll up or down until the desired entry is visible, and click on the entry to select it.

This pull-down list also appears in the lower area of the GEOTRANS File Processing window, where it displays the currently selected output datum that will be used for file processing, and can be used, as described above, to change that selection.

Easting/X:

This field is used to enter or display a projection X coordinate, also called an Easting, in meters. The format of projection coordinates consists of an optional sign (+/-) followed by a sequence of digits, optionally including a decimal point. The display of output Easting/X values may be affected by the setting of the Precision option, which causes the value to be rounded to the specified level of precision (e.g., 100m).

The range of valid Easting/X values varies for different projections. For UTM, Easting/X values must be between 100,000 and 900,000. For UPS, Easting/X values range from 0 up to 4,000,000. For most other map projections, the valid range of Easting/X values is calculated based on the current ellipsoid parameters and the map projection parameter values.

Examples:

500000

-200512

Ellipsoid:

This field displays the code and name of the currently selected input or output reference ellipsoid. You cannot select an ellipsoid directly; it is determined by the current input or output datum selection.

This field also appears in the lower area of the GEOTRANS File Processing window, where it displays the code and name of the output reference ellipsoid that will be used for file processing.

F-16 GRS Coordinate String:

This field is used to enter or display an F-16 Grid Reference System (GRS) coordinate string. An F-16 GRS coordinate string is a variant of an MGRS coordinate string (see below).

Document No. 5034289

Date: 23 October 2012

At 100,000m precision, an F-16 GRS coordinate string includes two trailing zeros, following the zone number, the zone letter, and the two-letter 100,000m square designation. In a standard MGRS coordinate string, the presence of these zeros would imply 10,000m precision. However, due to a quirk in the F-16 navigation system, strings of this form are used to designate a 100,000m square. Except for this quirk, F-16 GRS coordinates are identical to MGRS coordinates.

False Easting:

This field is used to enter or display a False Easting parameter for a particular projection. The False Easting defines the X projection coordinate value, in meters, at the origin of the projection, and is normally used to avoid having to deal with negative coordinate values. The format of a False Easting value consists of an optional sign (+/-) followed by a sequence of digits, optionally including a decimal point.

Examples:

500000 (UTM)

2000000 (UPS)

False Northing:

This field is used to enter or display a False Northing parameter for a particular projection. The False Northing defines the Y projection coordinate value, in meters, at the origin of the projection, and is normally used to avoid having to deal with negative coordinate values. The format of a False Northing value consists of an optional sign (+/-) followed by a sequence of digits, optionally including a decimal point.

Examples:

10000000 (UTM)

2000000 (UPS)

GARS Coordinate String:

This field is used to enter or display a GARS coordinate string. A GARS coordinate string is an alphanumeric string consisting of three digits followed by two letters and two digits.

The first three digits identify the 30 minute east/west quadrangle, ranging from 001 to 720. The next two letters identify the 30 minute north/south quadrangle, ranging from AA to QZ, omitting I and O. The next digit identifies a 15 minute cell within that quadrangle. This value ranges from 1 to 4, arranged left to right, top to bottom. The last digit identifies a 5 minute cell within

Document No. 5034289

Date: 23 October 2012

the 15 minute cell. This value ranges from 1 to 9, arranged as a keypad left to right, top to bottom.

Examples:

361HN (30 minute precision)

361HN3 (15 minute precision)

361HN37 (5 minute precision)

GEOREF Coordinate String:

This field is used to enter or display a GEOREF coordinate string. A GEOREF coordinate string is an alphanumeric string consisting of two pairs of letters, followed by a sequence of up to ten digits.

The first pair of letters identifies a 15° quadrangle. The first letter represents the southwest coordinate in the X direction (longitude). The 24 letters from A to Z (omitting I and O) correspond to the twenty-four GEOREF 15° longitude zones. The second letter represents the southwest coordinate in the Y direction (latitude). The 12 letters from A to M (omitting I) correspond to the twelve GEOREF 15° latitude zones for a total of 288 15° by 15° quadrangles globally.

The second pair of letters identifies a specific 1° by 1° GEOREF cell within the 15° by 15° quadrangle. The first letter represents the X coordinate (longitude) of the southwest corner of the cell. The 15 letters from A to Q (omitting I and O) correspond to the fifteen 1° longitude bands within the quadrangle. The second letter represents the Y coordinate (latitude) of the southwest corner of the cell. The 15 letters from A to Q (omitting I and O) correspond to the fifteen 1° latitude bands within the quadrangle. These letters partition each 15° by 15° GEOREF quadrangle into a total of 225 1° by 1° cells.

The remainder of the GEOREF coordinate string consists of the numeric longitude and latitude values within the 1° by 1° cell. The left half of the digit sequence is the longitude value, in decimal minutes, with an implied decimal point after the first two digits. The right half of the digit sequence is the latitude value, in decimal minutes, with an implied decimal point after the first two digits. Thus both the latitude and longitude have a maximum precision of 0.001 minute (approximately 2 meters). Both the longitude and the latitude value must have the same precision and must include leading zeros.

Examples:

GJQF4500030000 (0.001 minutes precision)

Document No. 5034289

Date: 23 October 2012

GJQF4530 (1 minute precision)

MKPG12000400 (0.01 minute precision)

Height:

This field is used to enter or display a height, in meters, relative to either the ellipsoid surface (i.e., an ellipsoidal height) or relative to the geoid surface (with WGS 84) or local mean sea level (i.e., a geoid/MSL height). Positive values are above the surface, while negative values are below the surface. The format of height values consists of an optional sign (+/-) followed by a sequence of digits, optionally including a decimal point. The display of ellipsoidal height values may be affected by the setting of the Precision option, which causes the value to be rounded to the specified level of precision (e.g., 10m).

Examples:

100

-1000

Height Type:

This pull-down list is used to specify or display the type of height values, if any, used with Geodetic coordinates.

Click on “Ellipsoid Height” to specify that the input, or desired output, height values are measured relative to the surface of the selected ellipsoid.

Click on “MSL-EGM2008-2.5M-BCS Height” to specify that the input, or desired output, height values are measured relative to the surface of the geoid defined by the Earth Gravity Model 2008 (EGM 2008), using a 2.5-minute grid and a bicubic spline interpolation method.

Click on “MSL-EGM96-15M-BL Height” to specify that the input, or desired output, height values are measured relative to the surface of the geoid defined by the Earth Gravity Model 1996 (EGM 96), using a 15-minute grid and a bilinear interpolation method.

Click on “MSL-EGM96-VG-NS Height” to specify that the input, or desired output, height values are measured relative to the surface of the geoid defined by EGM 96, using a variable resolution grid and a natural spline interpolation method. This is included for compatibility with older systems.

Click on “MSL-EGM84-10D-BL Height” to specify that the input, or desired output, height values are measured relative to the surface of the geoid defined by the Earth Gravity Model 1984

Document No. 5034289

Date: 23 October 2012

(EGM 84), using a 10-degree grid and a bilinear interpolation method. This is included for compatibility with older systems.

Click on “MSL-EGM84-10D-NS Height” to specify that the input, or desired output, height values are measured relative to the surface of the geoid defined by EGM 84, using a 10-degree grid and a natural spline interpolation. This is included for compatibility with older systems.

Click on “MSL-EGM84-30M-BL Height” to specify that the input, or desired output, height values are measured relative to the surface of the geoid defined by EGM 84, using a 30-minute grid and a natural spline interpolation. This is included for compatibility with older systems and is more accurate than MSL-EGM84-10D-BL Height.

Click on “No Height” if only two-dimensional Geodetic coordinates are being used.

Note that the Height Type selection is automatically set to No Height whenever the other currently selected coordinate reference system is two-dimensional. For file processing, the Height Type selection for output Geodetic coordinates is automatically set to No Height whenever the coordinate reference system specified in the input file is two-dimensional.

Hemisphere:

This pair of radio buttons is used to specify or display the hemisphere (Northern or Southern) for UPS and UTM projections. Click on the button labeled ‘N’ to select the Northern hemisphere, or on the button labeled ‘S’ to select the Southern hemisphere.

Latitude:

This field is used to enter or display a geodetic latitude value in decimal degrees, degrees/minutes, or degrees/minutes/seconds.

Latitude limits:

-90° to +90° (90°S to 90°N)

-90° at the South Pole

0° at the Equator

+90° at the North Pole

A latitude field can be entered or displayed in three different formats:

- sDD/MM/SS.SSSSh (degrees/minutes/seconds), where
 $-90 \leq DD \leq 90$
 $0 \leq MM < 60$

Document No. 5034289

Date: 23 October 2012

$$0 \leq \text{SS.SSSS} < 60$$

- sDD/MM.MMMMMMh (degrees/minutes), where

$$-90 \leq \text{DD} \leq 90$$

$$0 \leq \text{MM.MMMMMM} < 60$$

- sDD.DDDDDDDDDh where

$$-90 \leq \text{DD.DDDDDDDDD} \leq 90$$

Where s represents an optional sign (+ or -), and h represents an optional hemisphere (N or S, in either upper or lower case). The sign and hemisphere are mutually exclusive. If neither a sign nor a hemisphere is included, a positive value (Northern hemisphere) for degrees is assumed. Valid separators for the degrees, minutes, and seconds subfields are / (slash), : (colon), or a blank space.

Latitude values may be entered using any of the legal formats, or combinations thereof. The display format of output latitude values is controlled by the settings in the Options menu. The setting of the Geodetic Units option may be overridden by the setting of the Precision option. For example, if the Geodetic Units option is set to degrees/minutes/seconds, but the Precision option is set to 1 minute, the output value will be rounded to minutes and the seconds subfield will not be displayed.

Examples:

56/24/32.01 (degrees/minutes/seconds)

56 24 32.01 (degrees minutes seconds)

-34/32/34 (degrees/minutes/seconds)

34:32:34S (degrees:minutes:seconds)

+78/23.438 (degrees/minutes)

-82.8475647 (degrees)

Invalid Examples:

-56/24/32.01S (includes both sign and hemisphere)

120 45 31N (degrees subfield out of valid range)

60 99 59.99S (minutes subfield out of valid range)

5:**:00N (includes invalid characters)

Document No. 5034289

Date: 23 October 2012

(1st or 2nd) Latitude:

These fields are used to enter or display the Latitude 1 and Latitude 2 parameters of the Oblique Mercator projection. Latitude 1 and Latitude 2 are the latitude values of two points lying along the central line of the projection. See **Latitude** for the details of the format of this field.

Longitude:

This field is used to enter or display a geodetic latitude value in decimal degrees, degrees/minutes, or degrees/minutes/seconds.

Longitude limits:

-180° to +360° (180°W to 360°E)

0° at the Prime meridian

A longitude field can be entered or displayed in three different formats:

- sDDD/MM/SS.SSSSh (degrees/minutes/seconds)
 - 180 <= DDD <= 360
 - 0 <= MM < 60
 - 0 <= SS.SSSS < 60
- sDDD/MM.MMMMMMh (degrees/minutes)
 - 180 <= DDD <= 180
 - 0 <= MM.MMMM MM < 60
- sDDD.DDDDDDDh (degrees)
 - 180 <= DDD.DDDDDDD <= 180

Where s represents an optional sign (+ or -), and h represents an optional hemisphere (E or W, in either upper or lower case). The sign and hemisphere are mutually exclusive. If neither a sign nor a hemisphere is included, a positive value (Eastern hemisphere) for degrees is assumed. Valid separators for the degrees, minutes, and seconds subfields are / (slash), : (colon), or a blank space.

Longitude values may be entered using any of the legal formats, or combinations thereof. The display format of output longitude values is controlled by the settings in the Options menu. The setting of the Geodetic Units option may be overridden by the setting of the Precision option. For example, if the Geodetic Units option is set to degrees/minutes/seconds, but the Precision option is set to 1 minute, the output value will be rounded to minutes and the seconds subfield will not be displayed.

Document No. 5034289

Date: 23 October 2012

Examples:

156/24/32.01 (degrees/minutes/seconds)

-34/32/34 (degrees/minutes/seconds)

326 32 34 (degrees minutes seconds)

34:32:34W (degrees:minutes:seconds)

78/23.438 (degrees/minutes)

-82.8475647 (degrees)

Invalid Examples:

-56/24/32.01E (includes both sign and hemisphere)

200 45 31W (degrees subfield out of valid range)

60 99 59.99E (minutes subfield out of valid range)

5:**:00W (includes invalid characters)

(1st or 2nd) Longitude:

These fields are used to enter or display the Longitude 1 and Longitude 2 parameters of the Oblique Mercator projection. Longitude 1 and Longitude 2 are the longitude values of two points lying along the central line of the projection. See **Longitude** for the details of the format of this field.

MGRS Coordinate String:

This field is used to enter or display a Military Grid Reference System (MGRS) coordinate string. An MGRS coordinate string is an alphanumeric string consisting of a zone designation, a two-letter 100,000-meter grid square designator, and a sequence of up to ten digits, which provide Easting and Northing coordinates with the grid square with a precision of up to 1 meter. MGRS coordinates are defined for the primary UTM and UPS areas, but not for the overlap areas.

In the UTM area, the zone designation consists of the two-digit UTM zone number, with any leading zero included, followed by a zone letter that identifies a band of geodetic latitude. Beginning at 80°S and proceeding northward, the 20 latitude bands are lettered C through X, omitting I and O. The bands are all 8° high except band X (72°N to 84°N), which is 12° high.

In the UPS (polar) areas, the zone designation consists of a single letter, as follows:

A in the Southern and Western Hemispheres.

B in the Southern and Eastern Hemispheres.

Document No. 5034289

Date: 23 October 2012

Y in the Northern and Western Hemispheres.

Z in the Northern and Eastern Hemispheres.

The 100,000-meter grid square designator consists of a pair of letters. The letters which identify a particular 100,000-meter square depend on the ellipsoid, the zone, and the location within the zone.

The remainder of the MGRS coordinate string consists of the numeric Easting and Northing values within the 100,000-meter grid square. The left half of the digit sequence is the Easting value, which is read to the right from the left edge of the 100,000-meter grid square. The right half of the digit sequence is the Northing value, which is read northward from the bottom edge of the 100,000-meter grid square. Both the Easting and Northing values are within the range from 0 to 99,999 meters. Both Easting and Northing values must have the same precision and must include leading zeros.

Examples:

19KFC24782147 (10m precision)

YXK3526742583 (North polar area, 1m precision)

17MPT1704763023 (1m precision)

17MPT1763 (1km precision)

Northing/Y:

This field is used to enter or display a projection Y coordinate, also called a Northing, in meters. The format of projection coordinates consists of an optional sign (+/-) followed by a sequence of digits, optionally including a decimal point. The display of output Northing/Y values may be affected by the setting of the Precision option, which causes the value to be rounded to the specified level of precision (e.g., 100m).

The range of valid Northing values varies for different projections. For UTM, Northing/Y values range from 0 to 10,000,000. For UPS, Northing/Y values range from 0 up to 4,000,000. For other map projections, the range of valid Northing/Y values is calculated based on the current ellipsoid parameters and the parameters of the map projection.

Examples:

5000000

-1234567

Orientation:

This field is used to enter or display the Orientation of a Local Cartesian coordinate system. The Orientation is the clockwise rotation angle from north to the positive Y axis of a Local Cartesian coordinate system. See **Longitude** for the details of the format of this field.

Origin Height:

This field is used to enter or display the Origin Height of a Local Cartesian coordinate system. The Origin Height specifies the vertical portion of the location of the origin of a Local Cartesian coordinate system. It specifies the vertical location of the origin relative to the surface of the reference ellipsoid. See **Height** for the details of the format of this field.

Origin Latitude:

This field is used to enter or display the Origin Latitude parameter of a particular projection, or the Origin Latitude of a Local Cartesian coordinate system. The Origin Latitude is the latitude value at the vertical center of a projection, or specifies the latitude portion of the location of the origin of a Local Cartesian coordinate system. See **Latitude** for the details of the format of this field.

Origin Longitude:

This field is used to enter or display the Origin Longitude of a Local Cartesian coordinate system. The Origin Longitude specifies the longitude portion of the location of the origin of a Local Cartesian coordinate system. See **Longitude** for the details of the format of this field.

Override:

This control consists of a single radio button, plus a field in which an overriding UTM zone can be specified (see **Zone** below). When the check box or button is selected, the field must be filled in with a UTM zone value. UTM output coordinates will then be interpreted in terms of this zone, rather than their "natural" zone. The override zone must be adjacent to the natural zone, and the coordinates converted must be located within the overlap area of the override zone and the natural zone.

Scale Factor:

This field is used to enter or display the projection scale factor for a particular projection. The projection scale factor is the multiplier that reduces a distance in a map projection to the actual distance on the chosen reference ellipsoid. The values of this field are positive real numbers ranging from 0.3 to 3.0, with up to five decimal places.

Document No. 5034289

Date: 23 October 2012

Examples:

1.00000

0.9996

0.9994

Sources:

This pull-down list displays the names of possible sources for input sources. These include GPS coordinates, various types of hardcopy maps, and various types of digital geospatial data. Selecting one of these entries causes all three of the standard error fields (90%CE, 90%LE, and 90%SE) to be set to values appropriate for the selected source.

(1st or 2nd) Standard Parallel:

These fields are used to enter or display one of the Standard Parallel parameters of an Albers Equal Area Conic, Equidistant Cylindrical, Lambert Conformal Conic, Mercator, or Polar Stereographic map projection. A Standard Parallel is a latitude value where the projection surface intersects the surface of the reference ellipsoid, and the point scale factor is one. See Latitude for the details of the format of this field.

USNG Coordinate String:

This field is used to enter or display a United States National Grid (USNG) coordinate string. A USNG coordinate string is an alphanumeric string consisting of a zone designation, a two-letter 100,000-meter grid square designator, and a sequence of up to ten digits, which provide Easting and Northing coordinates with the grid square with a precision of up to 1 meter. USNG coordinates are defined for the primary UTM and UPS areas, but not for the overlap areas.

In the UTM area, the zone designation consists of the two-digit UTM zone number, with any leading zero included, followed by a zone letter that identifies a band of geodetic latitude. Beginning at 80°S and proceeding northward, the 20 latitude bands are lettered C through X, omitting I and O. The bands are all 8° high except band X (72°N to 84°N), which is 12° high.

In the UPS (polar) areas, the zone designation consists of a single letter, as follows:

A in the Southern and Western Hemispheres.

B in the Southern and Eastern Hemispheres.

Y in the Northern and Western Hemispheres.

Z in the Northern and Eastern Hemispheres.

Document No. 5034289

Date: 23 October 2012

The 100,000-meter grid square designator consists of a pair of letters. The letters which identify a particular 100,000-meter square depend on the ellipsoid, the zone, and the location within the zone.

The remainder of the USNG coordinate string consists of the numeric Easting and Northing values within the 100,000-meter grid square. The left half of the digit sequence is the Easting value, which is read to the right from the left edge of the 100,000-meter grid square. The right half of the digit sequence is the Northing value, which is read northward from the bottom edge of the 100,000-meter grid square. Both the Easting and Northing values are within the range from 0 to 99,999 meters. Both Easting and Northing values must have the same precision and must include leading zeros.

Examples:

19KFC24782147 (10m precision)

YXK3526742583 (North polar area, 1m precision)

17MPT1704763023 (1m precision)

17MPT1763 (1km precision)

X:

This field is used to enter or display a geocentric or local Cartesian X coordinate, in meters. The format of Cartesian coordinates consists of an option sign (+/-) followed by a sequence of digits, optionally including a decimal point. The display of Cartesian coordinate values may be affected by the setting of the Precision option, which causes the value to be rounded to the specified level of precision (e.g., 100m).

Examples:

6378137

-1234567

Y:

This field is used to enter or display a geocentric or local Cartesian Y coordinate, in meters. The format of Cartesian coordinates consists of an option sign (+/-) followed by a sequence of digits, optionally including a decimal point. The display of Cartesian coordinate values may be affected by the setting of the Precision option, which causes the value to be rounded to the specified level of precision (e.g. 100m).

Examples:

6378137

-1234567

Z:

This field is used to enter or display a geocentric or local Cartesian Y coordinate, in meters. The format of Cartesian coordinates consists of an option sign (+/-) followed by a sequence of digits, optionally including a decimal point. The display of Cartesian coordinate values may be affected by the setting of the Precision option, which causes the value to be rounded to the specified level of precision (e.g., 100m).

Examples:

6378137

+500

Zone:

This field is used to enter or display a UTM zone number. A UTM zone number identifies one of sixty 6°-wide longitudinal zones. Zones are numbered sequentially from west to east. Zone 1 is located between 180°W and 174°W. UTM zone numbers must be in the range from 1 to 60.

5.3 ERROR CONDITIONS

This paragraph summarizes the error messages that can be output by GEOTRANS. These messages fall into four different categories:

- Error messages that are generated during the initialization of the GEOTRANS application software.
- Error messages that are generated when a coordinate conversion operation is performed.
- Error messages that are generated when a user-defined datum or ellipsoid is created or deleted.
- Error messages that are generated during file processing.

Each of these types of error messages is summarized below.

5.3.1 INITIALIZATION ERROR MESSAGES

Initialization error messages are returned by the GEOTRANS coordinate transformation engine when it is unable to initialize properly.

The Initialization error messages are:

- Error initializing GEOTRANS engine: Unable to locate ellipsoid data file: ellips.dat!

- Error initializing GEOTRANS engine: Ellipsoid table is full!
- Error initializing GEOTRANS engine: Invalid ellipsoid code!
- Error initializing GEOTRANS engine: Unable to locate datum data files: 3_param.dat, 7_param.dat!
- Error initializing GEOTRANS engine: Datum table is full!
- Error initializing GEOTRANS engine: Unable to read datum file!
- Error initializing GEOTRANS engine: Unable to locate geoid data files: Und_min2.5x2.5_egm2008_WGS84_TideFree_reformatted, egm84.grd, egm96.grd, wwgrid.bin!
- Error initializing GEOTRANS engine: Unable to read geoid file!

Typically, multiple initialization error messages will be generated. After each of these messages have been acknowledged, a "Failed to create empty document" dialog box will appear.

Initialization failure most often occurs as a result of the application software being unable to open one or more of four key data files. GEOTRANS requires the data files 3_param.dat, 7_param.dat, ellips.dat, Und_min2.5x2.5_egm2008_WGS84_TideFree_reformatted, egm96.grd, egm84.grd and wwgrid.bin data files, which contain datum, ellipsoid, and geoid separation information. These data files are normally located in the ./data directory, and the GEOTRANS software looks for them there by default. As an alternative, you can define the environment variable MSPCCS_DATA, and place the files in the directory identified by this variable.

5.3.2 COORDINATE CONVERSION ERROR MESSAGES

Coordinate conversion error messages are returned by the GEOTRANS coordinate transformation engine when a parameter or coordinate value is invalid relative to a particular coordinate system or map projection. In some cases, all of the individual parameter or coordinate values may be valid, but the combination is not. It may also be possible for the input coordinates to be invalid relative to the output coordinate system or map projection after being converted. When any of these errors are detected during interactive operations, a message box is displayed, identifying either the input or the output coordinate system or map projection, and the parameter or coordinate value, or values, which are invalid. When any of these errors are detected during file processing, the same message is written to the output coordinate file in the form of a comment.

Each message includes a prefix that indicates whether the problem is in the input or output portion of the conversion process, and the coordinate type involved. For example, if the error occurred in a conversion from UTM to geodetic coordinates, the prefix will read "Input UTM Coordinates:"

The Coordinate Conversion warning messages are:

- Latitude is too far from Central Meridian, distortion may be significant – This warning indicates that the input coordinates are located too far from the central meridian of either the input or output projection, as indicated in the message prefix. The conversion is performed, but you should recheck the input coordinates and the Central Meridian parameter value.
- Location is not within valid domain for current datum – This warning indicates that the input coordinates are not located in the part of the world addressed by the current input or output datum, as indicated in the message prefix. The conversion is performed, but you should recheck the input coordinates and the input and output datum selections.

The Coordinate Conversion error messages are:

- 1st and 2nd Standard Parallels cannot both be zero – the 1st and 2nd Standard Parallel parameter values are both zero (i.e., the equator) and so do not define a valid projection cone.
- Central Meridian out of range – the Central Meridian parameter value for the input or output projection, as indicated in the message prefix, is outside the valid range for longitude values, which is from -180° to $+360^{\circ}$.
- Easting/X out of range – the Easting/X coordinate value is not valid for the input or output projection, as indicated by the message prefix. The value is too far from the False Easting parameter value for the projection. See the appropriate projection description in Appendix A for more details.
- Easting/Northing too far from center of projection– the combination of the Easting/X and Northing/Y coordinate values denote a point that is located too far from the center of the current input or output projection, as indicated by the message prefix.
- Invalid Standard Parallel – the Standard Parallel parameter value is not valid for the currently specified projection.

- Invalid 1st Standard Parallel – the 1st Standard Parallel parameter value is not valid for the currently specified Albers Equal Area Conic or Lambert Conformal Conic projection. The valid range is from -90° to $+90^{\circ}$, but does not include the poles themselves.
- Invalid 2nd Standard Parallel – the 2nd Standard Parallel parameter value is not valid for the currently specified Albers Equal Area Conic or Lambert Conformal Conic projection. The valid range is from -90° to $+90^{\circ}$, but does not include the poles themselves.
- Invalid British National Grid Coordinate String – the input British National Grid coordinate string does not contain a valid British National Grid coordinate value. The British National Grid coordinate string may contain invalid characters or may not be formatted correctly.
- Invalid GEOREF Coordinate String – the input GEOREF coordinate string does not contain a valid GEOREF coordinate value.
- Invalid MGRS Coordinate String – the input MGRS coordinate string does not contain a valid MGRS coordinate value. The MGRS string may not be formatted correctly, or the zone letter, zone number, 100,000m square designation, and easting/northing values specified by the string may not be consistent with one another.
- Invalid Zone – the UTM zone number specified does not have a valid value. The valid range for UTM zone numbers is from 1 to 60.
- Invalid Zone Override – the UTM zone number specified in the Set Zone field is too far from the "natural" UTM zone of the input coordinates. The specified zone must be adjacent to the natural zone of the input coordinates.
- Latitude out of range – the Latitude coordinate value is not valid for the input or output projection, as indicated by the message prefix. Depending on the projection, this may mean that the latitude value is too close to a pole or the equator, or is outside the valid range for latitude values, which is from -90° to $+90^{\circ}$.
- Latitude 1 out of range – the Latitude 1 parameter value for the input or output Oblique Mercator projection is not valid. Latitude 1 is outside the valid range for the first latitude values, which is from -90° to $+90^{\circ}$, not including the poles.
- Latitude 1 and Latitude 2 cannot be equal – Latitude 1 and Latitude 2 parameter values are the same.

- The latitude part of the GEOREF string is greater than 60 – the latitude portion of a GEOREF string must have a value in the range from 0000 to 5999.
- Latitude 2 out of range – the Latitude 2 parameter value for the input or output Oblique Mercator projection is not valid. Latitude 2 is outside the valid range for the second latitude values, which is from -90° to $+90^{\circ}$, not including the poles.
- Longitude out of range – the Longitude coordinate value is not valid for the input or output projection, as indicated by the message prefix. This means that the longitude value is outside the valid range for longitude values, which is from -180° to $+360^{\circ}$.
- Longitude 1 out of range – the Longitude 1 parameter value for the input or output Oblique Mercator projection is not valid. Longitude 1 is outside the valid range for latitude values, which is from -180° to $+360^{\circ}$.
- Longitude 2 out of range – the Longitude 2 parameter value for the input or output Oblique Mercator projection is not valid. Longitude 2 is outside the valid range for latitude values, which is from -180° to $+360^{\circ}$.
- The longitude part of the GEOREF string is greater than 60 – the longitude portion of a GEOREF string must have a value in the range from 0000 to 5999.
- Northing/Y out of range – the Northing/Y coordinate value is not valid for the input or output projection, as indicated by the message prefix. The value is too far from the False Northing parameter value for the projection. See the appropriate projection description in Appendix A for more details.
- Origin Latitude (or Latitude of True Scale) out of range – the Origin Latitude parameter value for the input or output projection, or Local Cartesian coordinate system, as indicated in the message prefix, is not valid. Depending on the projection, this may mean that the Origin Latitude is too close to a pole or the equator, or is outside the valid range for latitude values, which is from -90° to $+90^{\circ}$.
- Origin Longitude (or Longitude Down from Pole) out of range – the Origin Longitude parameter value for the input or output Polar Stereographic projection, or Local Cartesian coordinate system, as indicated in the message prefix, is not valid. This means that the Origin Longitude value is outside the valid range for longitude values, which is from -180° to $+360^{\circ}$.
- Point 1 and Point 2 cannot be in different hemispheres – Latitude 1 and Latitude 2 parameter values are in opposite hemispheres.

- Scale Factor out of range – the Scale Factor parameter value is not valid (i.e., either too large or too small) for the input or output projection, as indicated by the message prefix.
- Standard Parallels cannot be equal and opposite latitudes – the 1st and 2nd Standard Parallel parameter values denote the same latitude, but in opposite hemispheres. This would cause the projection cone to become a cylinder, and is not allowed.
- Coordinates are outside valid area – the specified British National Grid coordinate string is outside the valid conversion area.
- Ellipsoid must be Airy – the specified ellipsoid for a British National Grid coordinate must be Airy.
- Ellipsoid must be International – the specified ellipsoid for New Zealand Map Grid coordinates must be International.

See the descriptions of the indicated coordinate reference frame in Section 3 and Appendix A, and/or the description(s) of the indicated parameter or coordinate field(s) in paragraph 5.2.2 for more information on the valid ranges and valid combinations of parameter and coordinate values.

It is possible for the GEOTRANS application to output error messages other than those listed above. However, these error messages should never appear under normal circumstances, and indicate that the software is in an invalid internal state.

5.3.3 USER-DEFINED DATUM & ELLIPSOID ERROR MESSAGES

User-defined datum error messages may be generated when you use the Create... or Delete... commands in the Datum menu. When creating a new user-defined datum, if the code specified for the new datum is already in use, or if any of the parameters for the new datum are not value, an error message box will be displayed after the OK button is clicked. Once the error message is acknowledged, the message box disappears and you are returned to the Create Datum dialog box, where you may either correct the invalid inputs, or cancel the operation.

When deleting a user-defined datum, if the code specified for the datum to be deleted is not user-defined, an error message box will be displayed after the OK button is clicked. Once the error message is acknowledged, the message box disappears and you are returned to the Delete Datum dialog box, where you may either select another datum, or cancel the operation.

The user-defined datum error messages are:

- Unable to locate datum data file – the specified datum data file does not exist.

- Unable to read datum file – the specified datum data file cannot be read.
- Datum table overflow – the datum table has run out of available space. No more new datums can be created until the Datum module is modified to allocate additional space.
- Invalid local datum domain of validity – the specified latitude and longitude values do not form a valid bounding geodetic rectangle. The southernmost latitude is greater than the northernmost latitude, and/or the westernmost longitude is greater than the easternmost longitude. The bounding rectangle cannot cross the $\pm 180^\circ$ line.
- Latitude out of range – one or both of the latitude values specified for the domain of validity of the new datum is not valid.
- Longitude out of range – one or both of the longitude values specified for the domain of validity of the new datum is not valid.
- Specified code not user defined – the specified datum is not a user-defined datum.
- Invalid datum code – the specified datum is not recognized. It is not on the datum list (containing both provided and user-specified datums).
- Rotation values must be between -60.0 and 60.0 – the rotation to WGS84 is less than -60.0 or greater than 60.0 and is thus out of range.
- Scale factor out of range – the scale is less than -0.001 or greater than 0.001 and is thus out of range. The scale factor is a unitless value used in the WGS84 to local datum transformation as a scaling factor of $(1.0 + S)$, where S is in the range of -0.001 to +0.001.
- Standard error values must be positive, or -1 if unknown – one or more of the datum shift standard error values is negative, but is not -1. Correct the standard error value(s).

User-defined ellipsoid error messages may be generated when you use the Create... command in the Ellipsoid menu. When creating a user-defined ellipsoid, if the code specified for the new user-defined ellipsoid is already in use, or if the ellipsoid axis values are not valid, an error message box will be displayed after the OK button is clicked. Once the error message is acknowledged, the message box disappears and you are returned to the Create Ellipsoid dialog box, where you may either correct the invalid inputs, or cancel the operation.

When deleting a user-defined ellipsoid, if the code specified for the ellipsoid to be deleted is not user-defined, an error message box will be displayed after the OK button is clicked. Once the

error message is acknowledged, the message box disappears and you are returned to the Delete Ellipsoid dialog box, where you may either select another ellipsoid, or cancel the operation.

The user-defined ellipsoid error messages are:

- Unable to locate ellipsoid data file: ellips.dat – the ellips.dat file does not exist.
- Inverse flattening must be between 250 and 350 – self-explanatory. Correct the flattening value.
- Ellipsoid is in use by a datum – the user-defined ellipsoid is in use by a user-defined datum and cannot be deleted. You must delete all user-defined datums that use the ellipsoid before it can be deleted.
- Ellipsoid semi-major axis must be greater than zero – self-explanatory. Correct the semi-major axis value.
- Ellipsoid table overflow– the ellipsoid table has run out of available space. No more user-defined ellipsoids can be created until the Ellipsoid module is modified to allocate additional space.
- Specified code not user defined – the specified ellipsoid is not a user-defined ellipsoid.
- Invalid ellipsoid code – the specified ellipsoid is not recognized. It is not on the ellipsoid list (containing both provided and user-specified ellipsoids).

5.3.4 FILE PROCESSING ERROR MESSAGES

File processing error messages are generated when the header of an input coordinate file does not have the proper format, or when a particular set of coordinates in the body of an input coordinate file cannot be read successfully, or contains an illegal value. When an error is detected in the header of an input coordinate file, a message box is displayed, and file processing is aborted. When an error is detected in the body of an input coordinate file, a message is written to the output coordinate file in the form of a comment.

The File Processing input coordinate file header error messages are:

- Input file error opening file – the file designated by the specified path and file name could not be opened, probably because it does not exist. Recheck the file and directory/folder names, and try again.
- Input file error in keyword – a line in the input coordinate file header does not start with a recognizable keyword.

- Input file error in coordinate type – a line in the input coordinate file header starting with the keyword COORDINATES or PROJECTION did not contain a valid value.
- Input file error in datum – a line in the input coordinate file header starting with the keyword DATUM did not contain a valid datum code.
- Input file error in Central Meridian – a line in the input coordinate file header starting with the keyword CENTRAL MERIDIAN did not contain a legal value, or contained a value outside the valid range for a longitude (-180° to +360°).
- Input file error in Origin Latitude – a line in the input coordinate file header starting with the keyword ORIGIN LATITUDE did not contain a legal value, or contained a value outside the valid range for a latitude (-90° to +90°).
- Input file error in Origin Longitude– a line in the input coordinate file header starting with the keyword ORIGIN LONGITUDE did not contain a legal value, or contained a value outside the valid range for a longitude (-180° to +360°).
- Input file error in Origin Height– a line in the input coordinate file header starting with the keyword ORIGIN HEIGHT did not contain a legal value.
- Input file error in Standard Parallel – a line in the input coordinate file header starting with the keyword STANDARD PARALLEL did not contain a legal value, or contained a value outside the valid range for a latitude (-90° to +90°).
- Input file error in Standard Parallel 1 – a line in the input coordinate file header starting with the keyword STANDARD PARALLEL 1 did not contain a legal value, or contained a value outside the valid range for a latitude (-90° to +90°).
- Input file error in Standard Parallel 2 – a line in the input coordinate file header starting with the keyword STANDARD PARALLEL 2 did not contain a legal value, or contained a value outside the valid range for a latitude (-90° to +90°).
- Input file error in Latitude 1 – a line in the input coordinate file header starting with the keyword LATITUDE ONE did not contain a legal value, or contained a value outside the valid range for the first latitude (-89° to +89°, excluding the equator).
- Input file error in Longitude 1 – a line in the input coordinate file header starting with the keyword LONGITUDE ONE did not contain a legal value, or contained a value outside the valid range for a longitude (-180° to +360°).

- Input file error in Latitude 2 – a line in the input coordinate file header starting with the keyword LATITUDE TWO did not contain a legal value, or contained a value outside the valid range for the second latitude (-89° to $+89^{\circ}$).
- Input file error in Longitude 2 – a line in the input coordinate file header starting with the keyword LONGITUDE TWO did not contain a legal value, or contained a value outside the valid range for a longitude (-180° to $+360^{\circ}$).
- Input file error in False Easting – a line in the input coordinate file header starting with the keyword FALSE EASTING did not contain a legal value.
- Input file error in False Northing – a line in the input coordinate file header starting with the keyword FALSE NORTHING did not contain a legal value.
- Input file error in Scale Factor – a line in the input coordinate file header starting with the keyword SCALE FACTOR did not contain a legal value.
- Input file unknown error – the input coordinate file header could not be parsed successfully. Check to make sure that the specified file was actually a GEOTRANS coordinate file.

Unless otherwise indicated above, you should examine the header of the input coordinate file, and use a text editor to correct the error. See the description of the indicated field in paragraph 5.1.2 for information on the valid ranges of map projection parameter and coordinate values.

The File Processing input coordinate file body error messages are:

- Error reading coordinates from input file – the line containing a set of coordinates was not formatted properly, or contained one or more illegal coordinate values.

In addition, any of the coordinate conversion error messages contained in the previous paragraph can occur during file processing. These messages are written to the output coordinate file in the form of comments. The File Processing dialog box displays the number of such errors in the file when file processing is complete. Examine the line in the input coordinate file which corresponds to the line containing the error message in the output coordinate file (there is a one-to-one correspondence) and correct the contents of the input coordinate file using a text editor. See the descriptions of the coordinate systems in Appendix A, and the coordinate field descriptions in paragraph 5.2.2, for information on the valid formats and ranges of coordinate values.

5.4 ON-LINE HELP

The Help... command in the Help menu causes the on-line help subsystem to be activated. A standard browser (Internet Explorer or Netscape) is invoked to display the on-line help information. The content of the on-line help is based on the contents of this User's Guide.

When the on-line help subsystem is activated, a browser window appears displaying a hierarchical table of contents. Each entry in the table of contents is a hypertext link to the page containing the information described. Simply click on an entry to bring up a page containing information on the named topic. Related paragraphs are cross-linked so that you can easily navigate between related topics.

6. NOTES

This section contains additional supporting information. Paragraph 6.1 contains a glossary of relevant terms. Paragraph 6.2 contains a bibliography of relevant documents.

6.1 GLOSSARY

Circular Error (CE) – An accuracy figure representing the stated percentage of probability that any point expressed as a function of two linear components (e.g., horizontal position) will be within the given circle. Commonly used variations include CEP (50 percent), CE 1-sigma (39.35 percent), and CE (90 percent).

Confidence Interval – A statement of accuracy based on a statistic whose distribution function is known (e.g., the normal distribution function or bivariate normal distribution function). Errors are stated as some percentage of the total probability of 100 percent (e.g., a 90 confidence level). Also called assurance level, error interval, or probability interval.

Coordinate – Linear or angular quantities that designate the position that a point occupies in a given reference frame or system. Also used as a general term to designate the particular kind of reference frame or system, such as Cartesian coordinates or spherical coordinates.

Datum – Any numerical or geometrical quantity or set of such quantities specifying the reference coordinate system used for geodetic control in the calculation of coordinates of points on the earth. Datums may be either global or local in extent. A local datum defines a coordinate system that is used only over a region of limited extent. A global datum specifies the center of the reference ellipsoid to be located at the earth's center of mass and defines a coordinate system used for the entire earth.

Elevation – Vertical distance measured along the local plumb line from a vertical datum, usually mean sea level or the geoid, to a point on the earth.

Ellipsoid – The surface generated by an ellipse rotating about one of its axes. Also called ellipsoid of revolution.

Equator – The line of zero geodetic latitude; the great circle described by the semi-major axis of the reference ellipsoid as it is rotated about the semi-minor axis.

Equatorial Aspect – A variation of a particular map projection where the center of the projection is located on the equator.

Equipotential Surface – A surface with the same potential, usually gravitational potential, at every point; a level surface.

Geocentric Coordinates – Cartesian coordinates (X, Y, Z) that define the position of a point with respect to the center of mass of the earth.

Geodetic Coordinates (Geodetic Position) – The quantities of latitude, longitude, and geodetic height (ϕ , λ , h) that define the position of a point on the surface of the earth with respect to the reference ellipsoid.

Geodetic Height (Ellipsoid Height, HaE, h) – The height above the reference ellipsoid, measured along the ellipsoidal normal through the point in question. The geodetic height is positive if the point is outside the ellipsoid.

Geodetic Latitude (ϕ) – The angle between the plane of the Equator and the normal to the ellipsoid through the computation point. Geodetic latitude is positive north of the equator and negative south of the Equator.

Geodetic Longitude (λ) – The angle between the plane of a meridian and the plane of the prime meridian. A longitude can be measured from the angle formed between the local and prime meridians at the pole of rotation of the reference ellipsoid, or by the arc along the Equator intercepted by these meridians.

Geoid – The equipotential surface in the gravity field of the Earth that approximates the undisturbed mean sea level extended continuously through the continents. The geoid is the surface of reference for astronomic observations and geodetic leveling. Orthometric heights are referred to the surface of the geoid.

Geoid Separation (N) – The distance between the geoid and the mathematical reference ellipsoid as measured along the ellipsoidal normal. This distance is positive outside, or negative inside, the reference ellipsoid. Also called geoidal height; undulation of the geoid.

Grid Reference System – A plane-rectangular coordinate system usually based on, and mathematically adjusted to, a map projection in order that geodetic positions (latitudes and longitudes) may be readily transformed into plane coordinates and the computations relating to them may be made by the ordinary methods of plane surveying.

Horizontal Datum – A horizontal datum specifies the coordinate system in which latitude and longitude of points are located. The latitude and longitude of an initial point, the azimuth of a line from that point, and the semi-major axis and flattening of the ellipsoid that approximates the surface of the earth in the region of interest define a horizontal datum.

Linear Error (LE) – A one-dimensional error (such as an error in elevation) defined by the normal distribution function. Stated as a percentage of the probability that any point expressed as a function of a single linear component will be along the given line. Commonly used variations include Linear Standard Error or 1-sigma Error (68.27 percent), and LE (90 percent).

Map Projection – A function relating coordinates of points on a curved surface (usually an ellipsoid or sphere) to coordinates of points on a plane. A map projection may be established by analytical computation or, less commonly, may be constructed geometrically.

Map Scale – The ratio between a distance on a map and the corresponding actual distance on the earth's surface.

Mean Sea Level (MSL) – The average height for the surface of the sea for all stages of the tide, used as a reference for elevations. Also called Sea Level Datum. Mean Sea Level and the surface of the geoid are often assumed to coincide though in reality they are approximations to one another and can be offset by meters in some locations. GEOTRANS computes orthometric heights. However, because the MSL surface and the geoid surface are good approximations to each other in many locations, the more commonly used term MSL height is used to refer to these heights.

Meridian – A north-south reference line, particularly a great circle through the geographical poles of the earth, from which longitudes and azimuths are determined; or the intersection of a plane forming a great circle that contains both geographic poles of the earth, and the ellipsoid.

MSL Height – An elevation or height referenced to mean sea level.

Oblique Aspect – A variation of a particular map projection where the center of the projection is located neither at a pole, nor on the equator.

Orthometric Height – The distance of a point from the geoid measured along the direction of gravity at that point, with heights of points outside the geoid being treated as positive.

Parallel – A line on the earth, or a representation thereof, which represents the same latitude at every point.

Polar Aspect – A variation of a particular map projection where the center of the projection is located at a pole.

Prime Meridian – A meridian from which the longitudes of all other meridians are reckoned. This meridian, of longitude 0° , was traditionally chosen to pass through the Greenwich Observatory in Greenwich, England. For new refined coordinate systems, the location of the prime meridian is defined by the International earth Rotation Service, Paris, France.

Reference Ellipsoid – An ellipsoid, usually a bi-axial ellipsoid of revolution, whose dimensions closely approach the dimensions of the geoid; the exact dimensions are determined by various considerations of the section of the earth's surface concerned.

Scale Factor (Projection) – A multiplier for reducing a distance in a map projection to the actual distance on the chosen reference ellipsoid.

Spherical Error (SE) – The radius of a sphere within which there is a specified probability of locating a point. Spherical error is the three-dimensional analog of circular error. Commonly used are Spherical Error Probable (50 percent), and Spherical Error (90 percent).

Vertical Datum – A vertical datum is the surface to which elevations are referenced. A local vertical datum is a continuous surface, usually mean sea level, at which elevations are assumed to be zero throughout the area of interest.

6.2 BIBLIOGRAPHY

1. DMA TM 8358.1, **Datums, Ellipsoids, Grids, and Grid Reference Systems**, 1990.
2. DMA TM 8358.2, **The Universal Grids: Universal Transverse Mercator (UTM) and Universal Polar Stereographic (UPS)**, 1989.
3. MIL-STD-2401, **Department of Defense World Geodetic System (WGS)**, 1994.
4. STANAG 2211, **Geodetic Datums, ellipsoids, grids and grid references**, Fifth Edition, 1991.
5. TEC-SR-7, **Handbook for Transformation of Datums, Projections, Grids and Common Coordinate Systems**, 1996.
6. NGA, **Department of Defense Glossary of Mapping, Charting, and Geodetic Terms**, Fourth Edition, 1981.
7. Rapp, Richard H., **Geometric Geodesy - Part I; Department of Geodetic Science and Surveying**, The Ohio State University, Columbus, Ohio. 1984.
8. Rapp, Richard H., **Geometric Geodesy - Part II; Department of Geodetic Science and Surveying**, The Ohio State University, Columbus, Ohio. 1987.
9. Snyder, J. P., **Geological Survey Professional Paper 1395 Map Projections - A Working Manual**, 1987.
10. Federal Geographic Data Committee (FGDC), FGDC-STD-011-2001, **United States National Grid**, December 2001
11. <http://earth-info.nga.mil/GandG/coordsys/grids/gars.html>, **Global Area Reference System (GARS)**

A. COORDINATE REFERENCE FRAMES, DATUMS & ELLIPSOIDS

This section contains additional descriptive information on the coordinate reference frames, datums, and ellipsoids supported by GEOTRANS. Section A.1 describes each of the coordinate reference frame types supported. Section A.2 contains information on the supported datums and ellipsoids.

A.1 COORDINATE REFERENCE FRAMES

This section briefly describes each of the coordinate reference frame types currently supported by GEOTRANS. These include true coordinate systems, like Geocentric, map projections, like Mercator, and coding schemes like MGRS. The currently supported coordinate reference frames are:

- Geocentric coordinates
- Local Cartesian coordinates
- Geodetic coordinates
- World Geographic Reference System (GEOREF) coordinates
- Global Area Reference System (GARS) coordinates
- Mercator projection
- Transverse Mercator projection
- Universal Transverse Mercator (UTM) coordinates
- Polar Stereographic projection coordinates
- Universal Polar Stereographic (UPS) coordinates
- Military Grid Reference System (MGRS) coordinates
- United States National Grid (USNG) coordinates
- Albers Equal Area Conic projection
- Azimuthal Equidistant projection
- Bonne projection
- British National Grid coordinates
- Cassini projection

- Cylindrical Equal Area projection
- Eckert IV projection
- Eckert VI projection
- Equidistant Cylindrical projection
- Gnomonic projection
- Lambert Conformal Conic projection
- Miller Cylindrical projection
- Mollweide projection
- New Zealand Map Grid projection
- Ney's (Modified Lambert Conformal Conic) projection
- Oblique Mercator projection
- Orthographic projection
- Polyconic projection
- Sinusoidal projection
- Stereographic projection
- Transverse Cylindrical Equal Area projection
- Van der Grinten projection
- F-15 Grid Reference System

A.1.1 GEOCENTRIC COORDINATES

Geocentric coordinates are Cartesian coordinates (X , Y , Z) that define the position of a point relative to an origin located at the center of the reference ellipsoid. The coordinate system is a right-handed system, with the positive X axis emerging from the ellipsoid at the equator on the prime meridian, and the positive Z axis emerging from the ellipsoid at the north pole, as shown in Figure A-1.

A.1.2 LOCAL CARTESIAN COORDINATES

A local Cartesian coordinate system is primarily defined by the location of its origin, in geodetic coordinates. If the specified origin height is zero, the local XY plane is tangent to the surface of

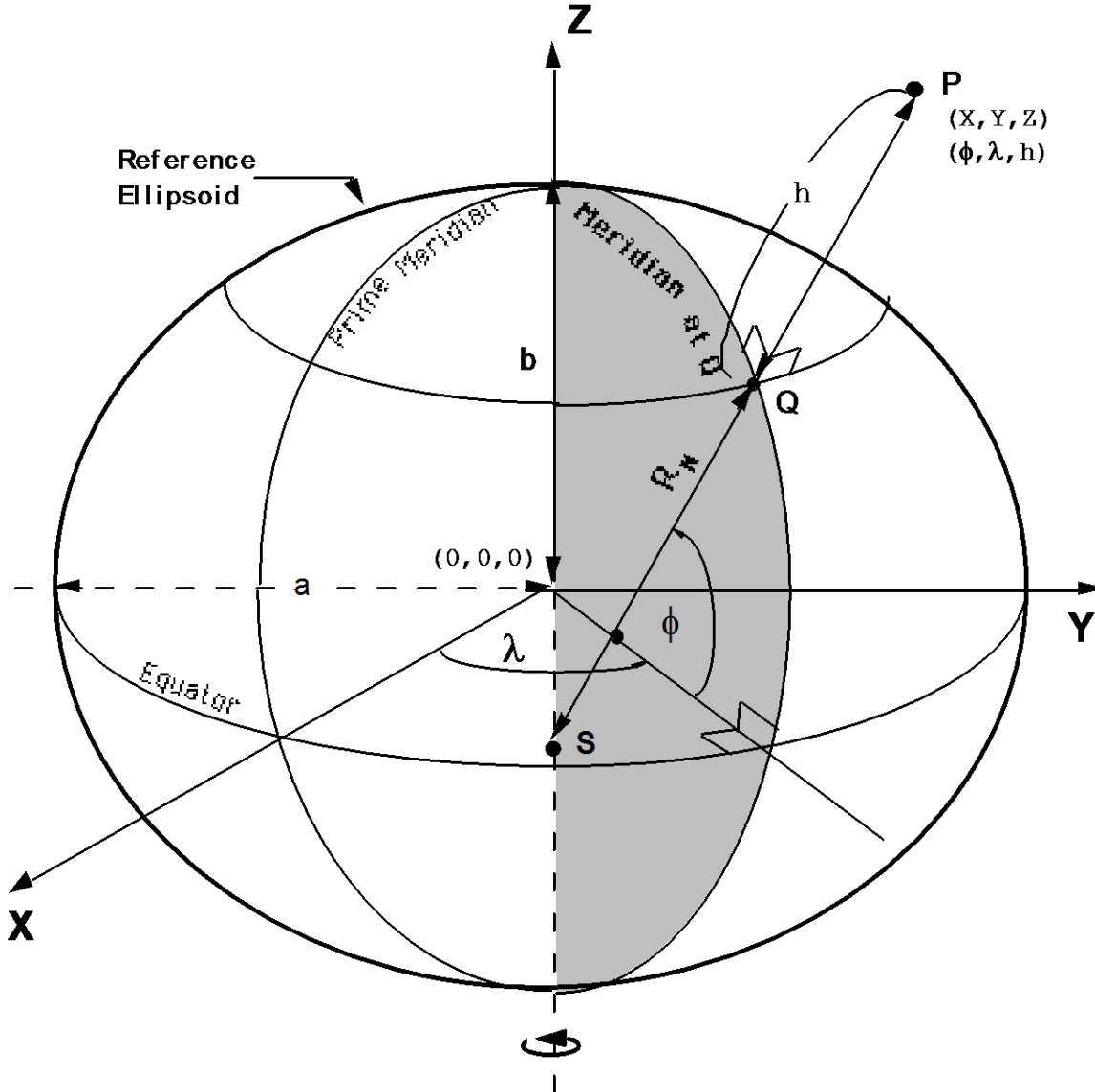

Figure A-1. Relationship Between Geocentric and Geodetic Coordinates

the reference ellipsoid at the specified origin. If the origin height is non-zero, the local XY plane is shifted up or down accordingly. If the specified orientation angle is zero, the local positive Y axis points north, while the local positive X axis points east, and the local positive Z axis points "up", perpendicular to the ellipsoid surface at the origin. If the orientation angle is not zero, then the local Cartesian coordinate system is rotated clockwise about the Z axis by the specified amount. For example, if the orientation angle is 90° , the local positive Y axis will point east, while the local positive X axis points south.

A.1.3 GEODETIC COORDINATES

Geodetic coordinates consist of geodetic latitude (ϕ), geodetic longitude (λ), and geodetic height (h), which define the position of a point with respect to the surface of a reference ellipsoid. Their relationship to the reference ellipsoid is shown in Figure A-1. The angle between the normal to the ellipsoid SP and the equatorial (X-Y) plane defines the geodetic latitude (ϕ) of point P. The meridian containing point P is defined as the half-plane containing the Z-axis and point P. The angle between the prime meridian (X-Z) plane and the meridian containing point P is the geodetic longitude (λ) of point P. Geodetic longitude is not defined when P lies on the Z-axis. The distance from Q to P is called the geodetic or ellipsoidal height (h).

Latitude limits:

-90° (90°S) to +90° (90°N)

Longitude limits:

0° to 360° or -180° (180°W) to +180° (180°E)

A.1.4 GEOREF COORDINATES

The World Geographic Reference System (GEOREF) is an alpha-numeric system for reporting positions for air defense and strategic air operations. It is based upon geodetic coordinates. The first two letters in a GEOREF coordinate string identify a 15° quadrangle, as shown in Figure A-2. The next two letters define a 1° cell within that quadrangle, shown in Figure A-3. The remaining digits define the location within the cell in terms of decimal minutes of longitude and latitude, with a maximum precision of 0.001 minutes (approximately 2 meters).

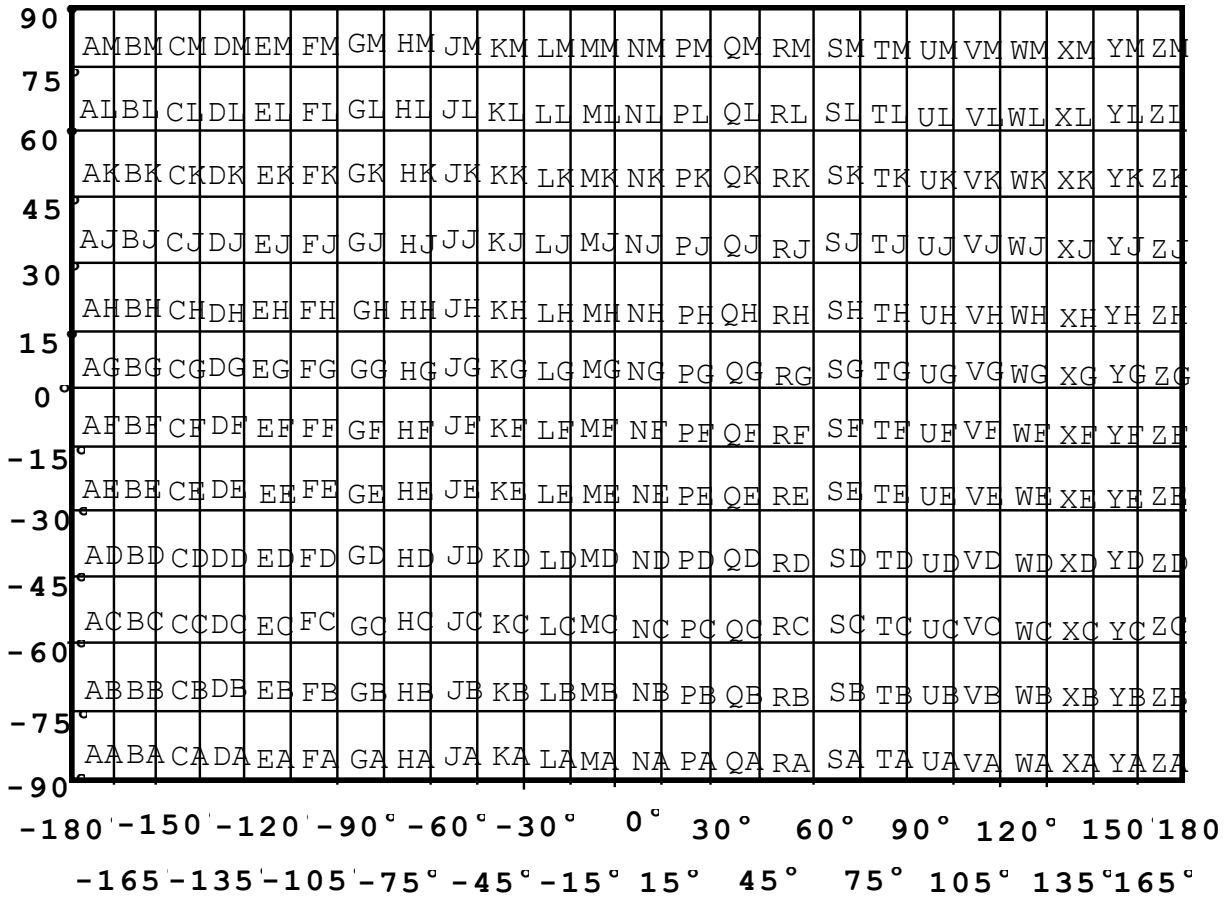

Figure A-2. GEOREF 15° Quadrangles

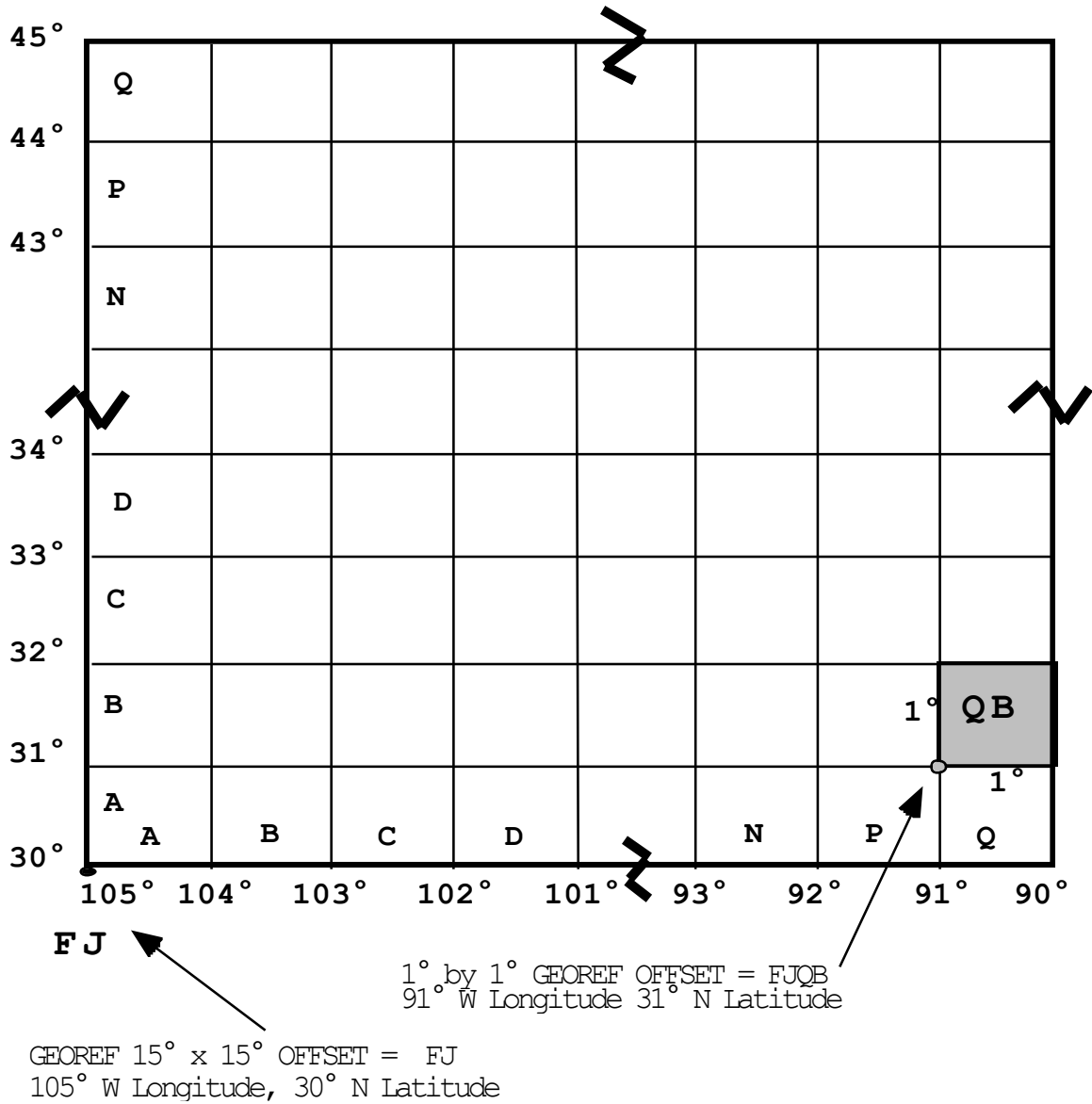

Figure A-3. GEOREF 1° Cells within a 15° Quadrangle

A.1.5 GARS COORDINATES

The Global Area Reference System (GARS) is an alpha-numeric system which divides the world into 30 minute cells using quadrant/keypad tiling. The first three numbers identify the 30 minute east/west quadrangle, ranging from 1 to 720. The next two letters identify the 30 minute north/south quadrangle, ranging from AA to QZ, omitting I and O. The next number identifies a 15 minute cell within that quadrangle. This value ranges from 1 to 4, arranged left to right, top to bottom. The last number identifies a 5 minute cell within the 15 minute cell. This value ranges from 1 to 9, arranged as a keypad left to right, top to bottom. See Figure A-4.

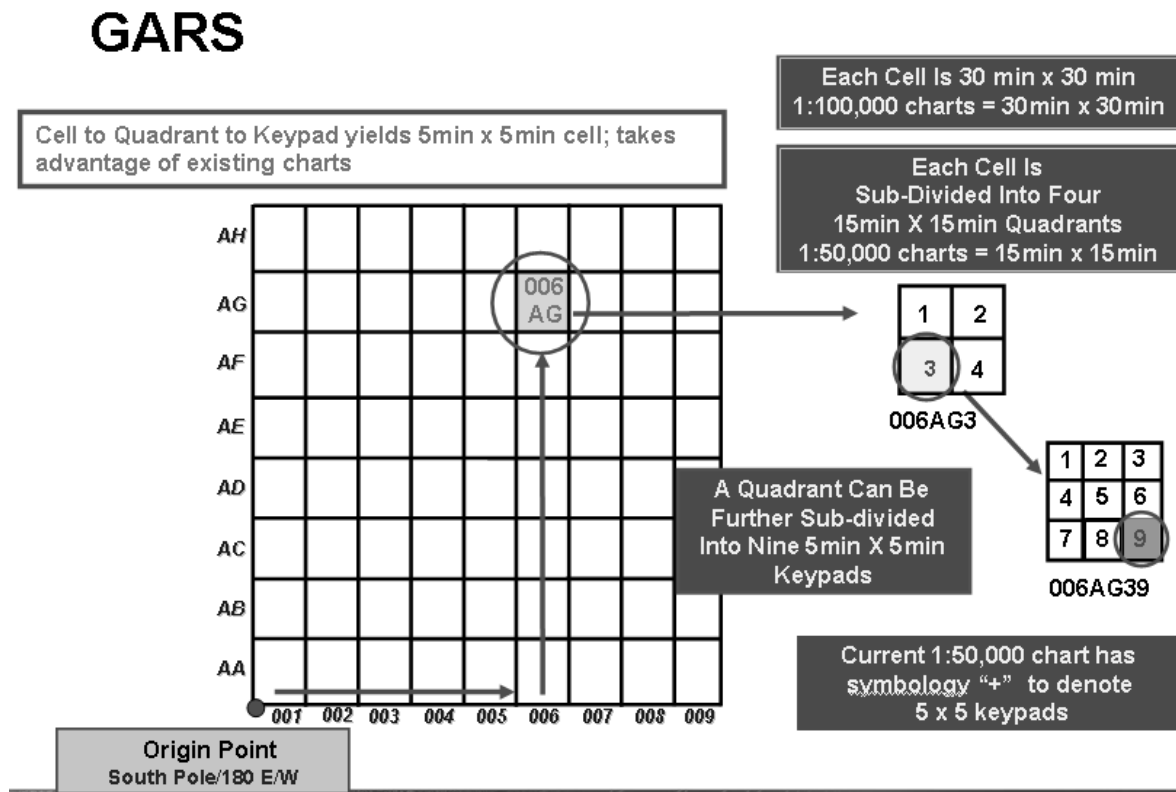

Figure A-4. GARS

A.1.6 MERCATOR PROJECTION

The Mercator projection is a conformal projection for which the point scale factor is one along the equator. The equator lies on the line $Y = 0$. This projection is not defined at the poles. Meridians and parallels provide the framework for the Mercator projection. Meridians are projected as parallel straight lines that satisfy the equation $X = a \text{ constant}$. Evenly spaced meridians on the ellipsoid project to evenly spaced straight lines on the projection. Parallels are projected as parallel straight lines perpendicular to meridians and satisfy the equation $Y = a \text{ constant}$. Evenly spaced parallels on the ellipsoid project to unevenly spaced parallels on the projection. The spacing between projected parallels increases with distance from the equator. See Figure A-5.

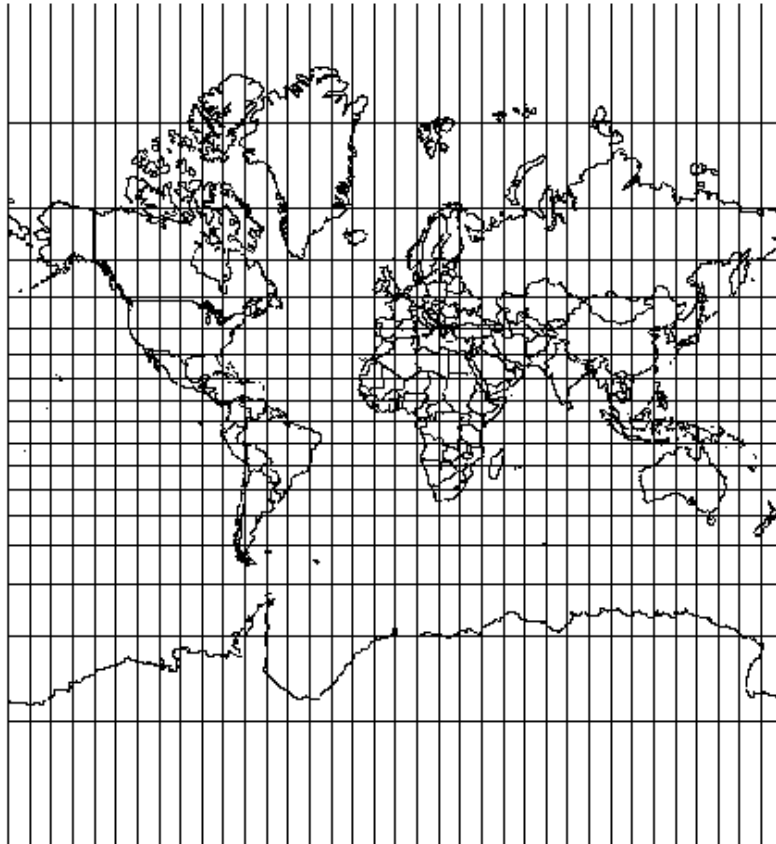

Figure A-5. Mercator Projection

In the Mercator projection, as the latitude approaches the poles, the Y coordinate approaches infinity. Area and length distortion increases with distance from the equator. For example, the point scale factor is approximately 2 at 60° latitude and is 5.7 at 80° latitude.

A.1.7 TRANSVERSE MERCATOR PROJECTION

The Transverse Mercator projection is a conformal projection for which the point scale factor equals one along the central meridian. The line $Y = 0$ is the projection of the equator, and the line $X = 0$ is the projection of the central meridian, as shown in Figure A-6.

Both the central meridian and the equator are represented as straight lines. No other meridian or parallel is projected onto a straight line. Since the point scale factor is one along the central meridian, this projection is most useful near the central meridian. Scale distortion increases away from this meridian.

The Transverse Mercator equations for X and Y, and for latitude and longitude, are approximations. Within 4° of the central meridian, the equations for X, Y, latitude, and longitude have an error of less than 1 centimeter.

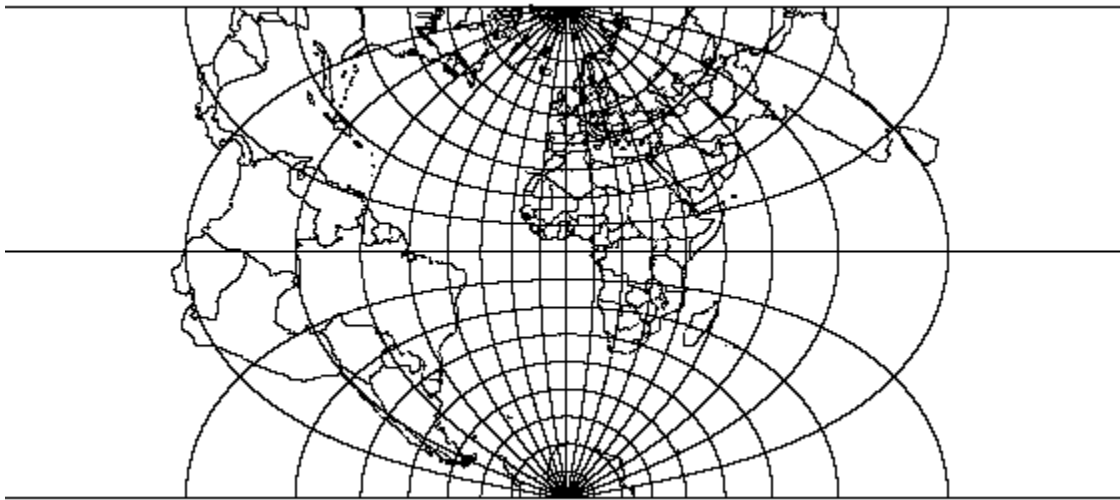

Figure A-6. Transverse Mercator Projection

A.1.8 UNIVERSAL TRANSVERSE MERCATOR (UTM) PROJECTION

UTM coordinates are based on a family of projections based on the Transverse Mercator projection, in which the ellipsoid is divided into 60 longitudinal zones of 6 degrees each. The X value, called the Easting, has a value of 500,000m at the central meridian of each zone. The Y

Document No. 5034289

Date: 23 October 2012

value, called the Northing, has a value of 0m at the equator for the northern hemisphere, increasing toward the north pole, and a value of 10,000,000m at the equator for the southern hemisphere, decreasing toward the south pole. The point scale factor along the central meridian is 0.9996.

For the UTM grid system, the ellipsoid is divided into 60 longitudinal zones of 6 degrees each. Zone number one lies between 180° W and 174° W. The zone numbers increase consecutively in the eastward direction. It is intended that a UTM projection should be used only in one of the 6-degree zones, plus the overlap area. GEOTRANS allows UTM output coordinates to be forced into either of the zones adjacent to the "natural" zone of the coordinates.

The area of coverage for UTM coordinates is defined by zone limits, latitude limits, and overlap.

Zone limits:

6° zones, extending 3° to each side of the central meridian. Note: there are several exceptions to this general rule, such as the irregular zones in the North Atlantic (refer to the A.1.11 MGRS COORDINATES).

Latitude limits:

North: 84°N

South: 80°S

Zone overlap:

40 km on either side of the zone limits.

Polar overlap:

30' toward the poles

North: 84° 30'N

South: 80° 30'S

A.1.9 POLAR STEREOGRAPHIC PROJECTION

The Polar Stereographic projection is a limiting case of the Lambert Conformal Conic projection when the standard parallels approach one of the poles. In this conformal projection meridians are straight lines, and parallels are concentric circles. The Central Meridian parameter determines the orientation of the projection. A value of zero results in projections as shown in Figure A-7. Increasing this value rotates the north polar projection clockwise, and the south polar projection counterclockwise.

A Polar Stereographic projection can be specified either in terms of a standard parallel, where the planar projection surface intersects the ellipsoid and the point scale factor is 1.0, or in terms of a point scale factor at the pole.

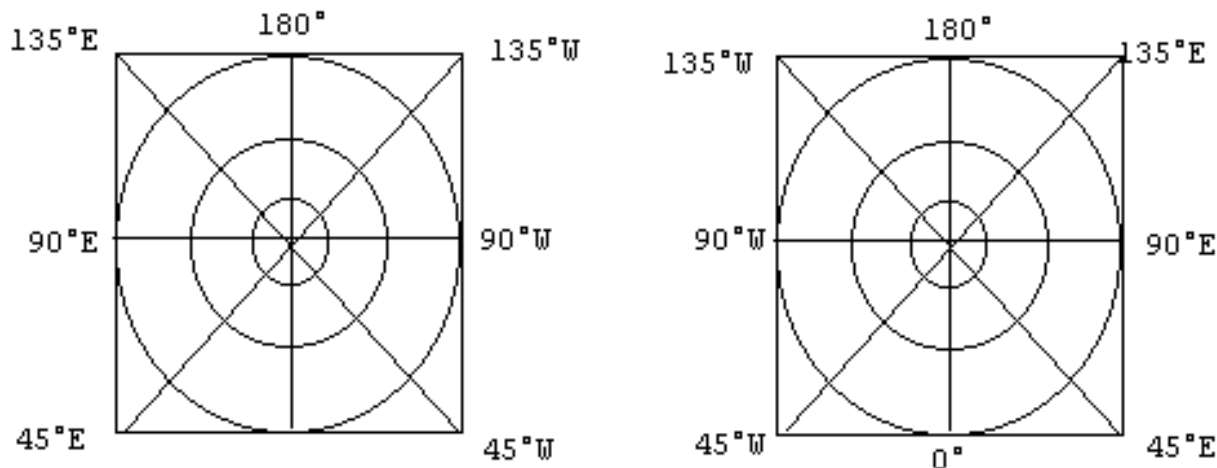

**Figure A-7. Meridians and Parallels in the Polar Stereographic Projection
(Left: South Zone, Right: North Zone. Not drawn to scale.)**

A.1.10 UNIVERSAL POLAR STEREOGRAPHIC (UPS) COORDINATES

Universal Polar Stereographic (UPS) is the standard military grid used in the polar regions. UPS is a family of two projections based on the Polar Stereographic projection, one for each of the poles. Both the X value, called the Easting, and the Y value, called the Northing, have values of 2,000,000m at the poles. The point scale factor at each pole is 0.994. The grid for the UPS northern polar zone is shown in Figure A-8.

The limits of the system are north of 84°N and south of 80°S. In order to provide a 30-minute overlap with the UTM grid, the UPS grid contains an overlap that extends to 83° 30'N and 79° 30'S. The area of coverage for UPS coordinates is defined by zone limits and overlap.

Zone limits:

North zone: 84°N to 90°N

South zone: 80°S to 90°S

UTM overlap: 30' overlap

North: 83° 30'N

South: 79° 30'S

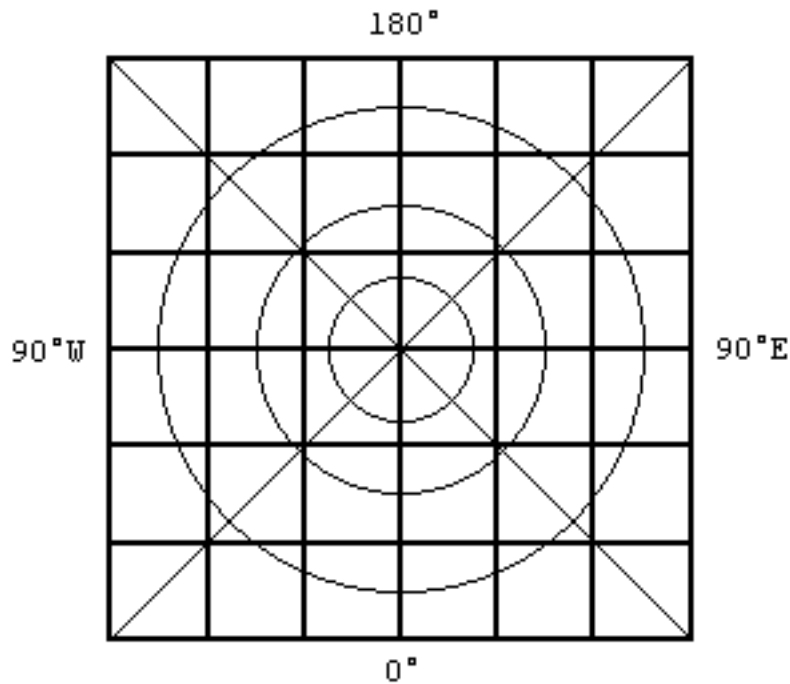

Figure A-8. Meridians and Parallels on a UPS Grid (North zone)

A.1.11 MGRS COORDINATES

The Military Grid Reference System (MGRS) is an alpha-numeric system, based upon the UTM and UPS map projections, for identifying positions. An MGRS coordinate consists of a zone designation, alphabetic 100,000-meter grid square designator, and numeric coordinates within the 100,000 meter grid square. MGRS coordinates are defined for the primary UTM and UPS areas, but not for the overlap areas.

In the UTM area, MGRS coordinates are based on the ellipsoid, geodetic latitude, UTM zone, Easting and Northing as follows:

- The first two characters of the MGRS coordinate are the two digits of the numeric UTM zone. Leading zeros must be included. Figure A-9 shows the layout of the zones, including the irregular zones in the North Atlantic.
- The third character of the MGRS coordinate is a letter representing a band of geodetic latitude. Beginning at 80°S and proceeding northward, the 20 bands are lettered C through X, omitting I and O. The bands are all 8° high except band X (72°N to 84°N), which is 12° high. Figure A-9 shows the layout of these bands.

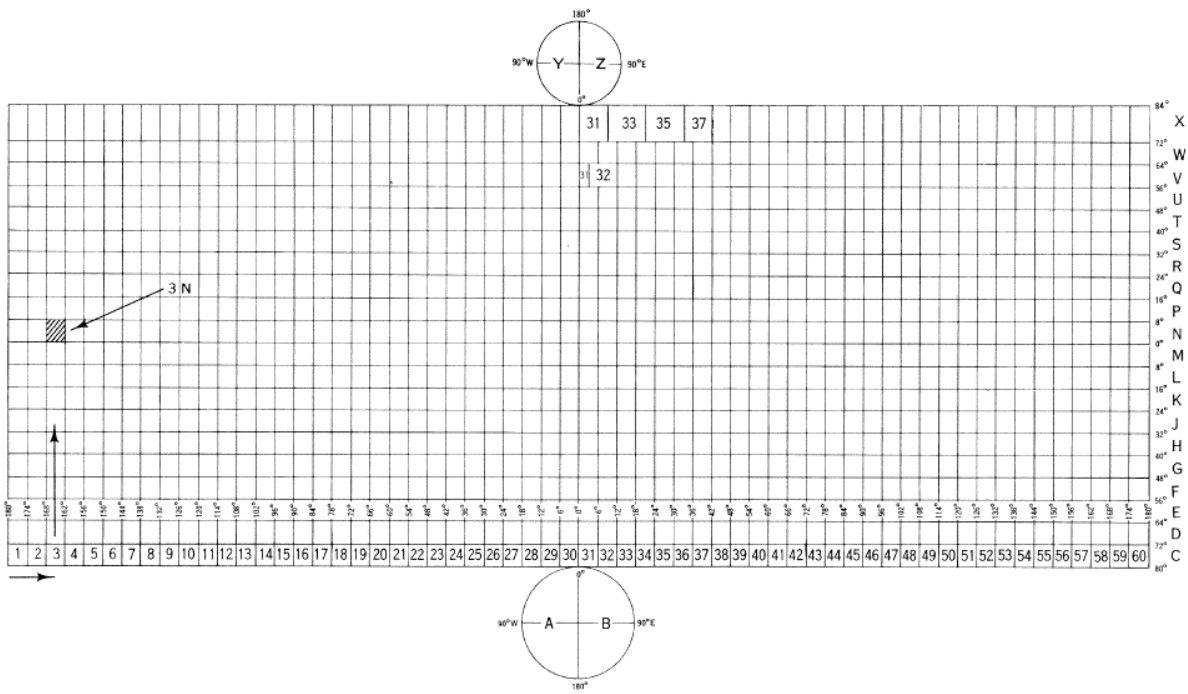

Figure A-9. MGRS Zones and Bands

- The fourth and fifth characters of the MGRS coordinate are a pair of letters representing the 100,000-meter grid square. Two different patterns of two-letter designations are used, depending on the ellipsoid associated with the current datum. Figure A-10 shows the pattern of 100,000 meter square designations used with the Clarke 1866, Clarke 1880, Bessel 1841 and Bessel 1841 Namibia ellipsoids. Figure A-11 shows the pattern used with all other ellipsoids. The patterns are repeated every six zones.
- Note: The alphabetic method of designating 100,000-meter grid squares has changed over time. Older products may have different grid square designations.
- The remainder of the MGRS coordinate string consists of the numeric Easting and Northing values within the 100,000-meter grid square. The left half of the digit sequence is the Easting value, which is read to the right from the left edge of the 100,000-meter grid square. The right half of the digit sequence is the Northing value, which is read northward from the bottom edge of the 100,000-meter grid square. Both the Easting and Northing values are within the range from 0 to 99,999 meters. Both Easting and Northing values must have the same precision and must include leading zeros.

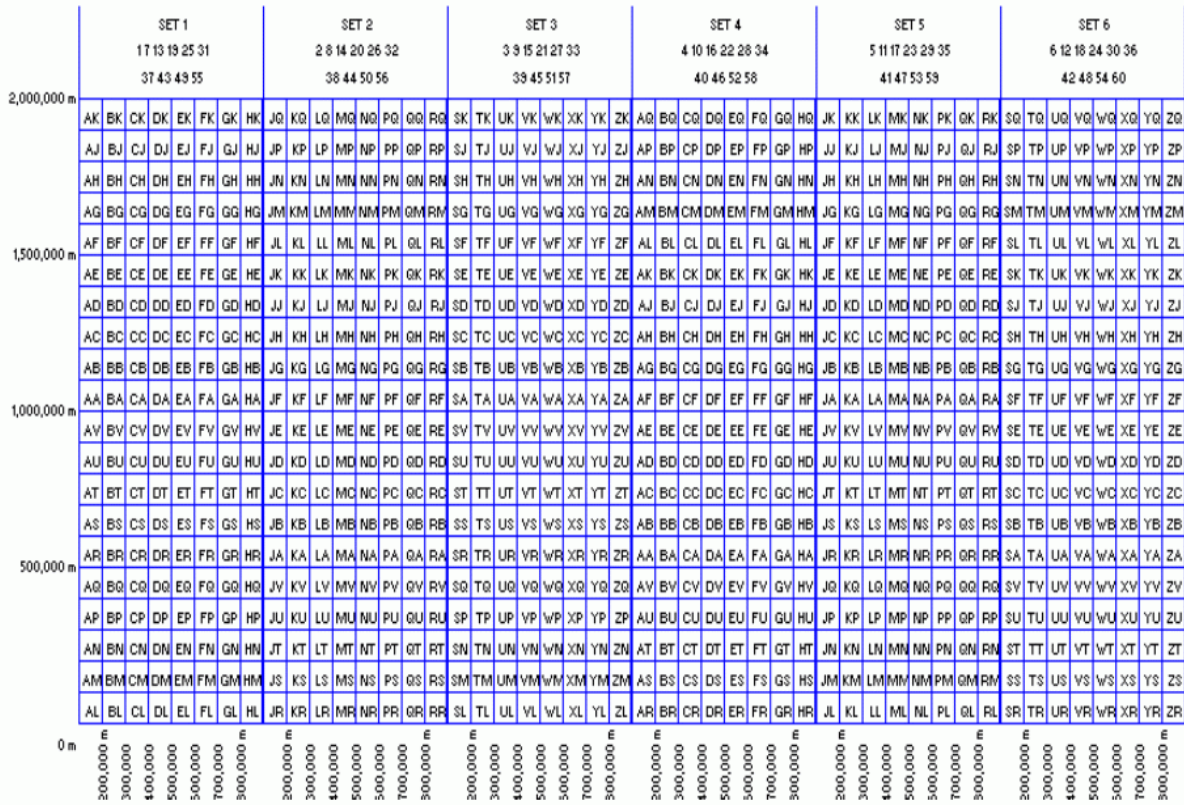

Figure A-10. MGRS 100,000m Square Designations (AL Pattern)

	SET 1 17 13 19 25 31 37 43 49 55						SET 2 2 8 14 20 26 32 38 44 50 56						SET 3 3 9 15 21 27 33 39 45 51 57						SET 4 4 10 16 22 28 34 40 46 52 58						SET 5 5 11 17 23 29 35 41 47 53 59						SET 6 6 12 18 24 30 36 42 48 54 60																			
2,000,000 m	AV	BV	CV	DV	EV	FV	GV	HV	JE	KE	LE	ME	NE	PE	QE	RE	SV	TV	UV	VV	WV	XV	YV	ZV	AE	BE	CE	DE	EE	FE	GE	HE	JV	KV	LV	MV	NV	PV	QV	RV	SE	TE	UE	VE	WE	XE	YE	ZE		
	AU	BU	CU	DU	EU	FU	GU	HU	JD	KD	LD	MD	ND	PD	QD	RD	SU	TU	UU	VU	WU	XU	YU	ZU	AD	BD	CD	DD	ED	FD	GD	HD	IU	KU	LU	MU	NU	PU	QU	RU	SD	TD	UD	VD	WD	XD	YD	ZD		
	AT	BT	CT	DT	ET	FT	GT	HT	JC	KC	LC	MC	NC	PC	QC	RC	ST	TT	UT	VT	WT	XT	YT	ZT	AC	BC	CC	DC	EC	FC	GC	HC	IT	KT	LT	MT	NT	PT	QT	RT	SC	TC	UC	VC	WC	XC	YC	ZC		
	AS	BS	CS	DS	ES	FS	GS	HS	JB	KB	LB	MB	NB	PB	QB	RB	SS	TS	US	VS	WS	XS	YS	ZS	AB	BB	CB	DB	EB	FB	GB	HB	IS	KS	LS	MS	NS	OS	RS	SB	TB	UB	VB	WB	XB	YB	ZB			
1,500,000 m	AR	BR	CR	DR	ER	FR	GR	HR	JA	KA	LA	MA	NA	PA	QA	RA	SR	TR	UR	VR	WR	XR	YR	ZR	AA	BA	CA	DA	EA	FA	GA	HA	IR	KR	LR	MR	NR	PR	QR	RR	SA	TA	UA	VA	WA	XA	YA	ZA		
	AQ	BQ	CQ	DQ	EQ	FQ	GQ	HQ	JV	KV	LV	MV	NV	PV	QV	RV	SQ	TQ	UQ	VQ	WQ	XQ	YQ	ZQ	AV	BV	CV	DV	EV	FV	GV	HV	IQ	KQ	LQ	MQ	NQ	PQ	QQ	RQ	SQ	TQ	UQ	VQ	WQ	XQ	YQ	ZQ		
	AP	BP	CP	DP	EP	FP	GP	HP	JU	KU	LU	MU	NU	PU	QU	RU	SP	TP	UP	VP	WP	XP	YP	ZP	AU	BU	CU	DU	EU	FU	GU	HU	IP	KP	LP	MP	NP	OP	QP	RP	SU	TU	UU	VU	WU	XU	YU	ZU		
	AN	BN	CN	DN	EN	FN	GN	HN	IT	KT	LT	MT	NT	PT	QT	RT	SN	TN	UN	VN	WN	XN	YN	ZN	AT	BT	CT	DT	ET	FT	GT	HT	IN	KN	LN	MN	NM	PN	QN	RN	ST	TT	UT	VT	WT	XT	YT	ZT		
	AM	BM	CM	DM	EM	FM	GM	HM	IS	KS	LS	MS	NS	OS	QS	RS	SM	TM	UM	VM	WM	XM	YM	ZM	AS	BS	CS	DS	ES	FS	GS	HS	IM	KM	LM	MM	NM	PM	QM	RM	SS	TS	US	VS	WS	XS	YS	ZS		
1,000,000 m	AL	BL	CL	DL	EL	FL	GL	HL	JR	KR	LR	MR	NR	PR	QR	RR	SL	TL	UL	VL	WL	XL	YL	ZL	AR	BR	CR	DR	ER	FR	GR	HR	IL	KL	LL	ML	NL	PL	QL	RL	SR	TR	UR	VR	WR	XR	YR	ZR		
	AK	BK	CK	DK	EK	FK	GK	HK	JQ	KQ	LQ	MQ	NQ	PQ	QQ	RQ	SK	TK	UK	VK	WK	XK	YK	ZK	AQ	BQ	CQ	DQ	EQ	FQ	GQ	HQ	IK	KK	LK	MK	NK	PK	QK	RK	SQ	TQ	UQ	VQ	WQ	XQ	YQ	ZQ		
	AJ	BJ	CJ	DJ	EJ	FJ	GJ	HJ	JP	KP	LP	MP	NP	OP	QP	RP	SJ	TJ	UJ	VJ	WJ	XJ	YJ	ZJ	AP	BP	CP	DP	EP	FP	GP	HP	IJ	KJ	LJ	MJ	NJ	PJ	QJ	RJ	SJ	TP	UP	VP	WP	XP	YP	ZP		
	AH	BH	CH	DH	EH	FH	GH	HJ	IN	KN	LN	MN	NN	PN	QN	RN	SH	TH	UH	VH	WH	XH	YH	ZH	AN	BN	CN	DN	EN	FN	GN	HN	IJ	KH	LH	MH	NH	PH	QH	RH	SH	TN	UN	VN	WN	XN	YN	ZN		
	AG	BG	CG	DG	EG	FG	GG	HG	IM	JM	KM	LM	MM	NM	PM	QM	RM	SG	TG	UG	VG	WG	XG	YG	ZG	AM	BM	CM	DM	EM	FM	GM	HM	IG	JG	KG	LG	MG	NG	OG	QG	RG	SM	TM	UM	VM	WM	XM	YM	ZM
500,000 m	AF	BF	CF	DF	EF	FF	GF	HF	JL	KL	LL	ML	NL	PL	QL	RL	SF	TF	UF	VF	WF	XF	YF	ZF	AL	BL	CL	DL	EL	FL	GL	HL	IF	KF	LF	MF	NF	PF	QF	RF	SL	TL	UL	VL	WL	XL	YL	ZL		
	AE	BE	CE	DE	EE	FE	GE	HE	JK	KK	LK	MK	NK	PK	QK	RK	SE	TE	UE	VE	WE	XE	YE	ZE	AK	BK	CK	DK	EK	FK	GK	HK	IE	KE	LE	ME	NE	PE	QE	RE	SK	TK	UK	VK	WK	XK	YK	ZK		
	AD	BD	CD	DD	ED	FD	GD	HD	JJ	KJ	LJ	MJ	NJ	PJ	QJ	RJ	SJ	TD	UD	VD	WD	XD	YD	ZD	AJ	BJ	CJ	DJ	EJ	FJ	GJ	HJ	JD	KD	LD	MD	ND	PD	QD	RD	SJ	TJ	UJ	VJ	WJ	XJ	YJ	ZJ		
	AC	BC	CC	DC	EC	FC	GC	HC	JH	KH	LH	MH	NH	PH	QH	RH	SC	TC	UC	VC	WC	XC	YC	ZC	AH	BH	CH	DH	EH	FH	GH	HH	IC	KC	LC	MC	NC	PC	QC	RC	SH	TH	UH	VH	WH	XH	YH	ZH		
	AB	BB	CB	DB	EB	FB	GB	HB	JG	KG	LG	MG	NG	PG	QG	RG	SB	TB	UB	VB	WB	XB	YB	ZB	AG	BG	CG	DG	EG	FG	GG	HG	IB	KB	LB	MB	NB	PB	QB	RB	SG	TG	UG	VG	WG	XG	YG	ZG		
0 m	AA	BA	CA	DA	EA	FA	GA	HA	JF	KF	LF	MF	NF	PF	QF	RF	SA	TA	UA	VA	WA	XA	YA	ZA	AF	BF	CF	DF	EF	FF	GF	HF	IA	KA	LA	MA	NA	PA	QA	RA	SF	TF	UF	VF	WF	XF	YF	ZF		

Figure A-11. MGRS 100,000m Square Designations (AA Pattern)

In the UPS area, MGRS coordinates are based on the ellipsoid, geodetic latitude and longitude, Easting, and Northing as follows:

- The first character of the MGRS coordinate is:
 - A in the Southern and Western Hemispheres.
 - B in the Southern and Eastern Hemispheres.
 - Y in the Northern and Western Hemispheres.
 - Z in the Northern and Eastern Hemispheres.
- The second and third characters of the MGRS coordinate are letters representing a 100,000 meter grid square. Figure A-12 shows the layout of the 100,000 meter squares in the north polar zone, while Figure A-13 shows the layout in the south polar zone.
- The method for calculating the remainder of the MGRS coordinate is the same as for the UTM area above.

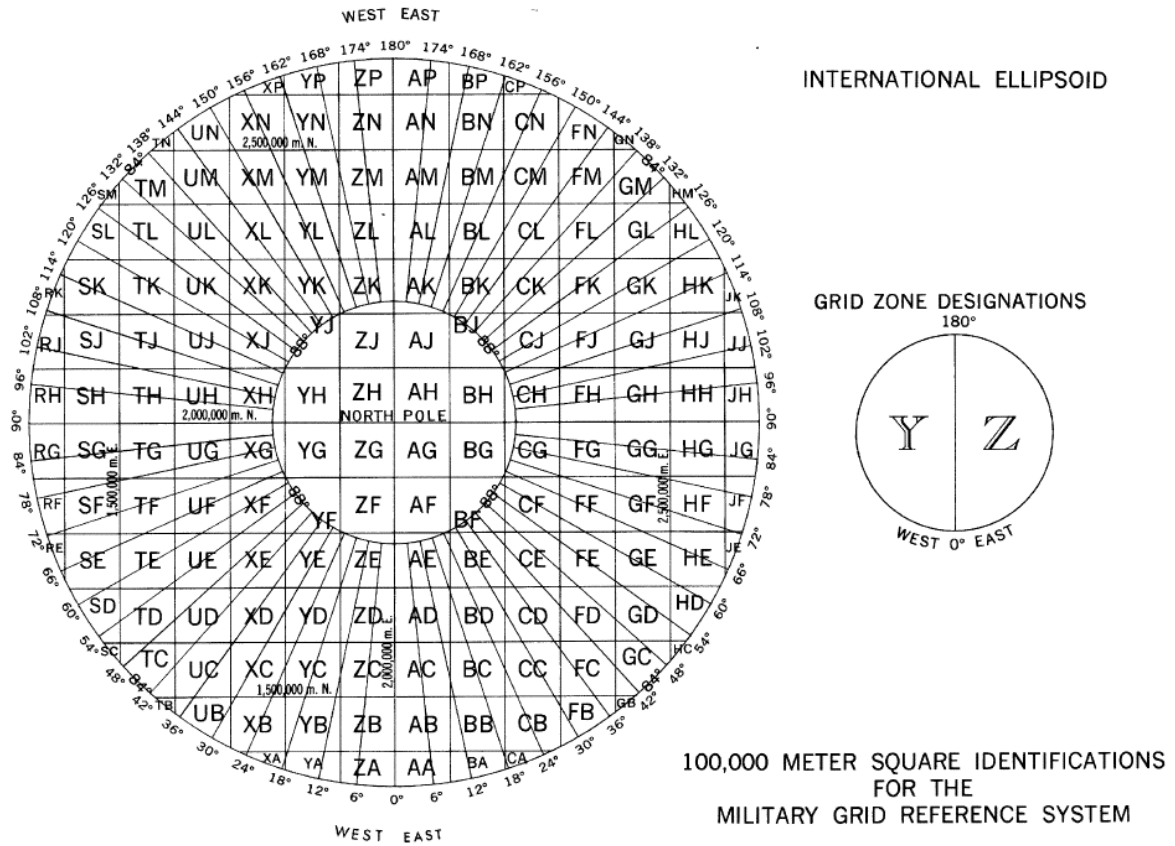

Figure A-12. MGRS 100,000m Square Designations for North Polar Zone

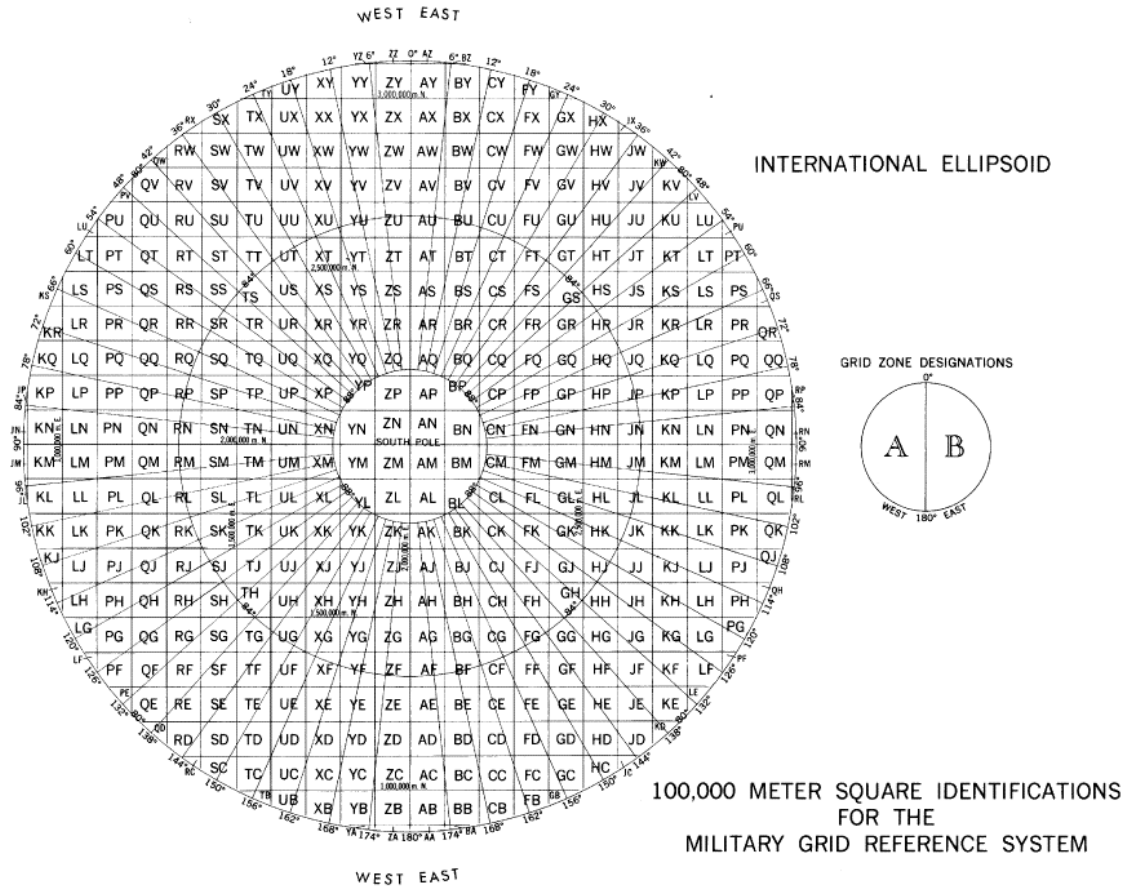
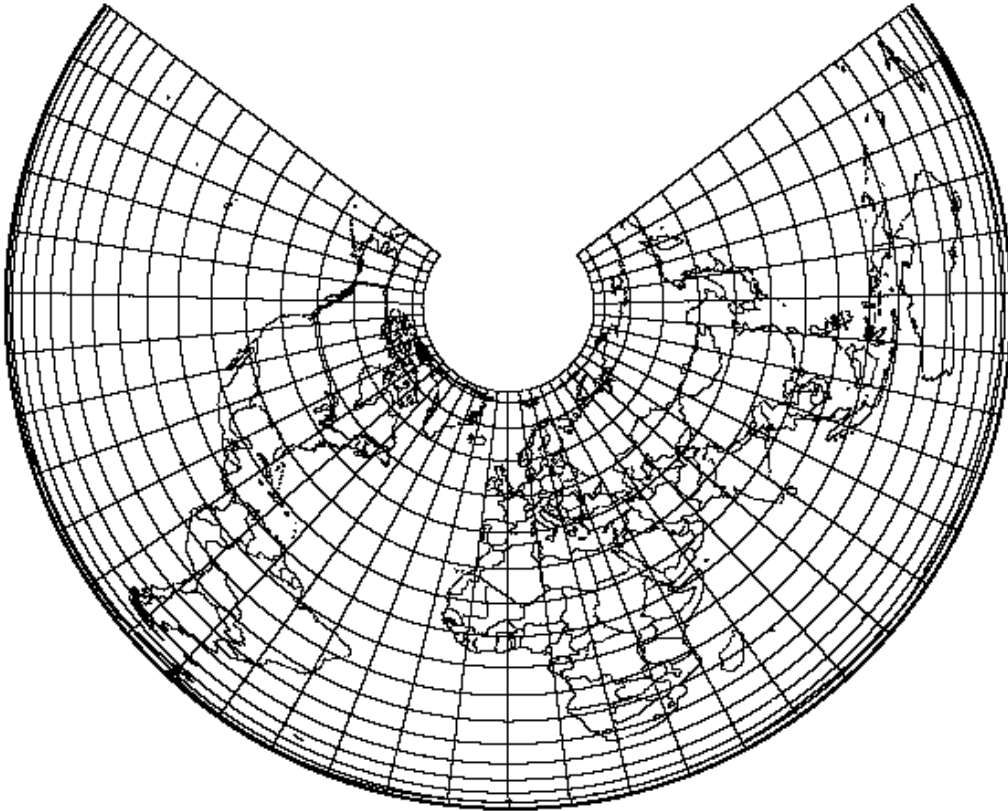

Figure A-13. MGRS 100,000m Square Designations for South Polar Zone

A.1.12 ALBERS EQUAL AREA CONIC PROJECTION

The Albers Equal Area Conic projection is a conical, equal area projection. As shown in Figure A-14, the meridians are equally spaced, straight, converging lines. The angles between the meridians are less than the true angles. Meridians intersect the parallels at right angles. Parallels are unequally spaced arcs of concentric circles. The parallels are closer together at the northernmost and southernmost regions of the map. They are further apart in the latitudes between the standard parallels. The poles are normally circular arcs that enclose the same angle as that enclosed by the other parallels for a given range of longitude. The Albers Equal Area Conic projection is symmetrical about any meridian.

Scale is true along the two standard parallels. It is also true even when there is only one standard parallel. Standard parallels should be chosen to minimize scale variations. Scale is true along any given parallel. The scale factor along the meridians is the reciprocal of the scale factor along the parallels, to retain equal area.



**Figure A-14. Albers Equal Area Conic Projection
(Origin Latitude = 45°N, Standard Parallels = 40°N & 50°N)**

The Albers Equal Area Conic projection is free of scale and shape distortion along either the one or two standard parallels. Along any given parallel, distortion is constant.

The standard parallels can not both be 0° or the opposite sign of each other, as this would cause the cone to become a cylinder.

A.1.13 AZIMUTHAL EQUIDISTANT PROJECTION

The Azimuthal Equidistant projection is an azimuthal, equidistant, non-perspective projection. As shown in Figure A-15, the meridians are straight lines on the polar aspect and complex curves on the equatorial and oblique aspects. The central meridian on the equatorial and oblique aspects is a straight line. Parallels on the polar aspect are circles, equally spaced, centered at the pole, which is a point. Parallels on the equatorial and oblique aspects are complex curves equally spaced along the central meridian. The equator is a straight line on the equatorial aspect. The projection is symmetrical about any meridian for the polar aspect, the equator or central meridian for the equatorial aspect, and the central meridian for the oblique aspect.

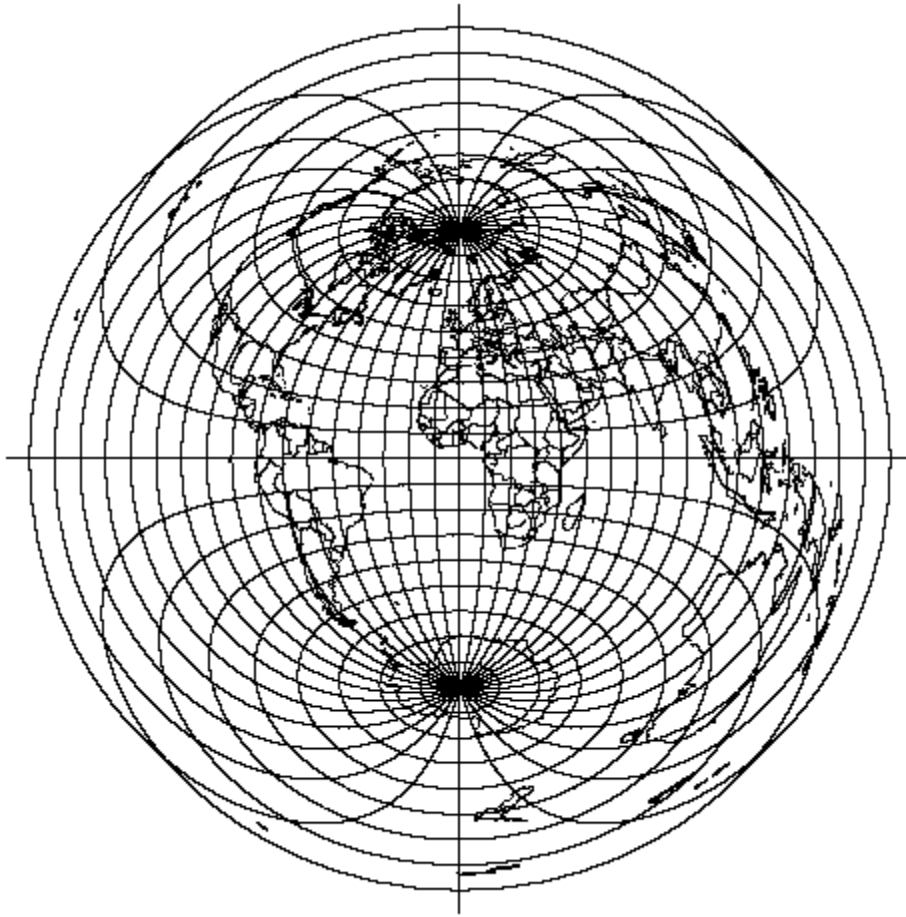

Figure A-15. Azimuthal Equidistant Projection

Scale is true along any straight line radiating from the center of the projection. A point opposite the center is projected as a circle twice the radius of the mapped equator. Scale along this circle is infinite.

The projection is free of distortion at the center. Distortion is severe for a world map.

A.1.14 BONNE PROJECTION

The Bonne projection is a pseudoconical, equal area projection. As shown in Figure A-16, the central meridian is a straight line, while other meridians are complex curves which connect equally spaced points along each parallel of latitude and concave toward the central meridian. Parallels are concentric circular arcs spaced at true distances along the central meridian. The curvature of the standard parallel is equal to that of its curvature on a cone tangent at that latitude. The poles are points.

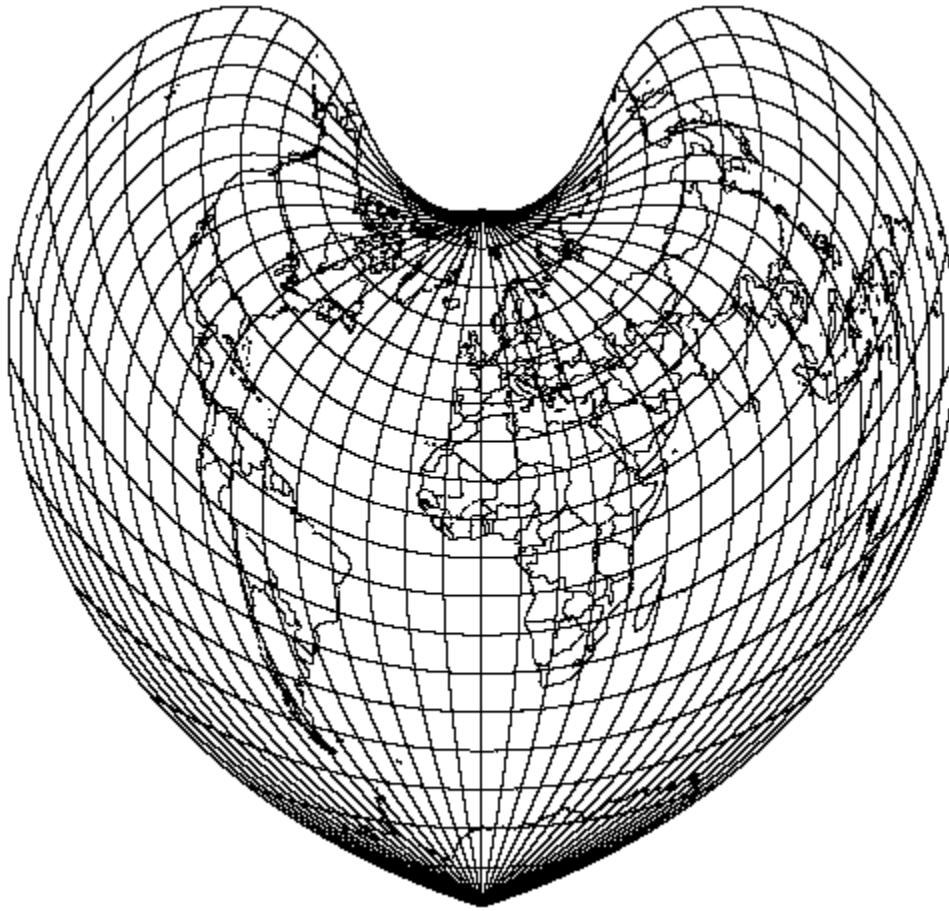

Figure A-16. Bonne Projection
(Origin Latitude = 45°N)

Scale is true along the central meridian and each parallel.

There is no distortion along the central meridian and the standard parallel. As distance from the central meridian and the standard parallel increases, shape distortion increases and meridians do not intersect parallels at right angles.

Sinusoidal is a limiting form of the Bonne projection with the standard parallel at the equator. The equations must be rewritten, since the parallels of latitude are straight.

A.1.15 BRITISH NATIONAL GRID COORDINATES

The British National Grid Reference System is an alphanumeric system for identifying positions. It is based on the Transverse Mercator map projection described in section A.1.31. A British National Grid coordinate consists of an alphabetic 500,000 unit grid square identifier, an

Document No. 5034289

Date: 23 October 2012

alphabetic 100,000 unit grid square identifier, and grid coordinates expressed to a given precision.

British National Grid parameters are fixed at an Origin Latitude of 49°N , Central Meridian of 2°W , False Easting of 400,000 meters, False Northing of -100,000 meters and a Scale Factor of .9996012717.

British National Grid uses only the Airy ellipsoid.

The coordinate SV 0000000000 is located at an Easting of 0m and a Northing of 0m in Transverse Mercator coordinates, which is the bottom, left most coordinate in Figure A-17.



Figure A-17. British National Grid

A.1.16 CASSINI PROJECTION

The Cassini projection is a cylindrical, equidistant projection. As shown in Figure A-18, the central meridian, each meridian 90° from the central meridian, and the equator are straight lines. Other meridians and parallels are complex curves, which are concave toward the central meridian and the nearest pole. The poles are points along the central meridian. Cassini is symmetrical about any straight meridian or the equator.

Scale is true along the central meridian and lines perpendicular to the central meridian. Scale increases with distance from the central meridian, along a direction parallel to the central meridian.

There is no distortion along the central meridian. If the longitude is greater than 4° from the central meridian, distortion will result. Horizontal straight lines, near the upper and lower limits, represent microscopic circles on the globe 90° from the central meridian.

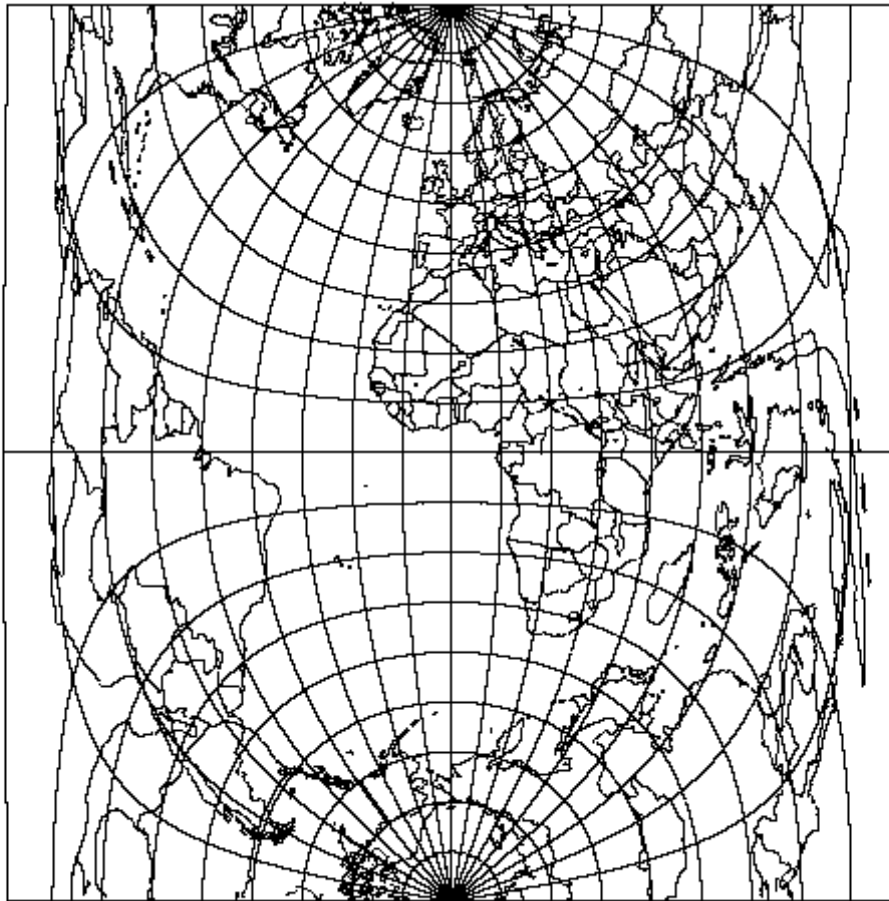

Figure A-18. Cassini Projection

A.1.17 CYLINDRICAL EQUAL AREA PROJECTION

The Cylindrical Equal Area projection is a cylindrical, equal area projection. It is an orthographic projection of a sphere onto a cylinder. As shown in Figure A-19, the meridians are equally spaced, straight, parallel lines almost $\frac{1}{3}$ the length of the equator. The parallels are unequally spaced, straight parallel lines perpendicular to the meridians. The parallels are spaced in proportion to the sine of the latitude from the equator. The poles are straight lines as long as the equator. The Cylindrical Equal Area projection is symmetrical about the equator or any meridian.

Scale is true along the equator. In the direction of the parallels, scale increases with distance from the equator and decreases in the direction of the meridians. Parallels of opposite sign have the same scale.

The Cylindrical Equal Area projection does not have area distortion anywhere. There is severe shape distortion at the poles.

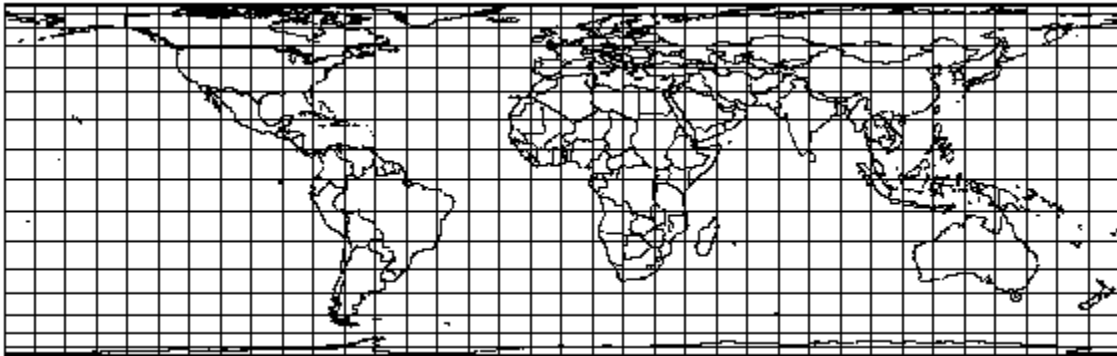

Figure A-19. Cylindrical Equal Area Projection

A.1.18 ECKERT IV PROJECTION

The Eckert IV projection is a pseudocylindrical, equal area projection. As shown in Figure A-20, the central meridian is a straight line half as long as the equator. The 180° east and west meridians are semicircles. All other meridians are equally spaced elliptical arcs. The parallels are unequally spaced, straight, parallel lines that are farthest apart at the equator. The parallels are perpendicular to the central meridian. The poles are straight lines half as long as the equator. Eckert IV is symmetrical about the central meridian or the equator.

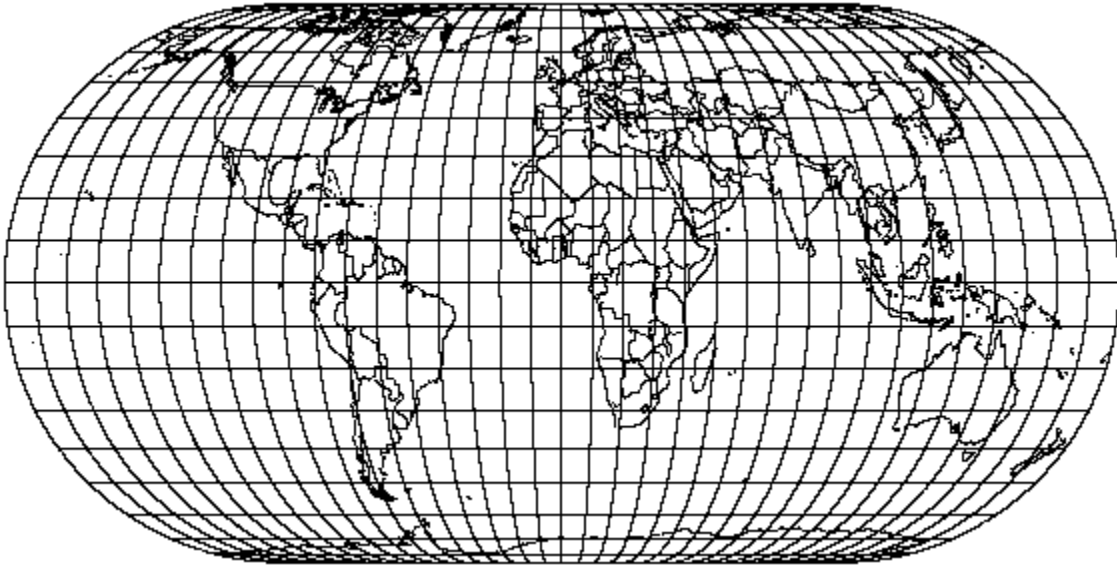

Figure A-20. Eckert IV Projection

Scale is true along latitudes $40^{\circ}30'$ N. and S. For any given latitude and the latitude of opposite sign, scale is constant.

Eckert IV is free of distortion only at latitudes $40^{\circ}30'$ N. and S. at the central meridian. The Eckert IV projection is used only in the spherical form.

A.1.19 ECKERT VI PROJECTION

The Eckert VI projection is a pseudocylindrical, equal area projection. As shown in Figure A-21, the central meridian is a straight line half as long as the equator. The other meridians are equally spaced sinusoidal curves. The parallels are unequally spaced, straight, parallel lines that are farthest apart at the equator. The parallels are perpendicular to the central meridian. The poles are straight lines half as long as the equator. Eckert VI is symmetrical about the central meridian or the equator.

Scale is true along latitudes $49^{\circ}16'$ N. and S. For any given latitude and the latitude of opposite sign, scale is constant.

Eckert VI is free of distortion only at latitudes $49^{\circ}16'$ N. and S. at the central meridian. The Eckert VI projection is used only in the spherical form.

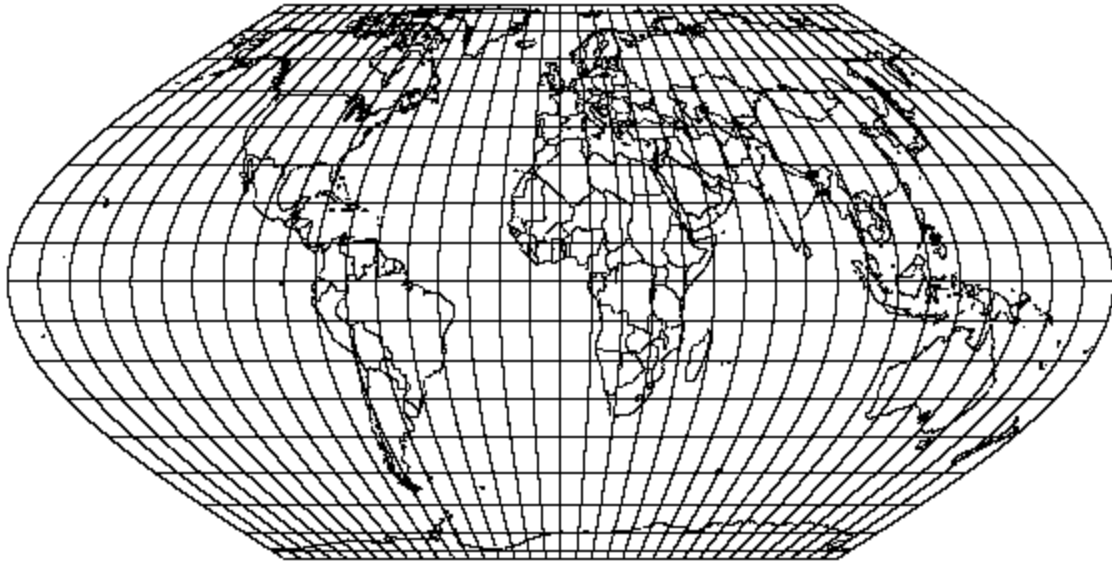

Figure A-21. Eckert VI Projection

A.1.20 EQUIDISTANT CYLINDRICAL PROJECTION

The Equidistant Cylindrical projection is a cylindrical equidistant projection. As shown in Figure A-22, the meridians are equally spaced, straight, parallel lines more than half as long as the equator. The parallels are equally spaced, straight, parallel lines perpendicular to the meridians. Meridian spacing is four-fifths of the parallel spacing. The poles are straight lines as long as the equator. The Equidistant Cylindrical projection is symmetrical about any meridian or the equator.

Scale is true along two standard parallels equidistant from the equator and along all meridians. Scale is small along the equator but increases along the parallels with distance from the equator. For any given parallel, scale is constant and equal to the scale at the parallel of opposite sign.

Infinitesimally small circles on the globe are circles on the map at the chosen standard parallels of 30° N. and S. Area and local shape are distorted everywhere else. The Equidistant Cylindrical projection is used only in the spherical form.

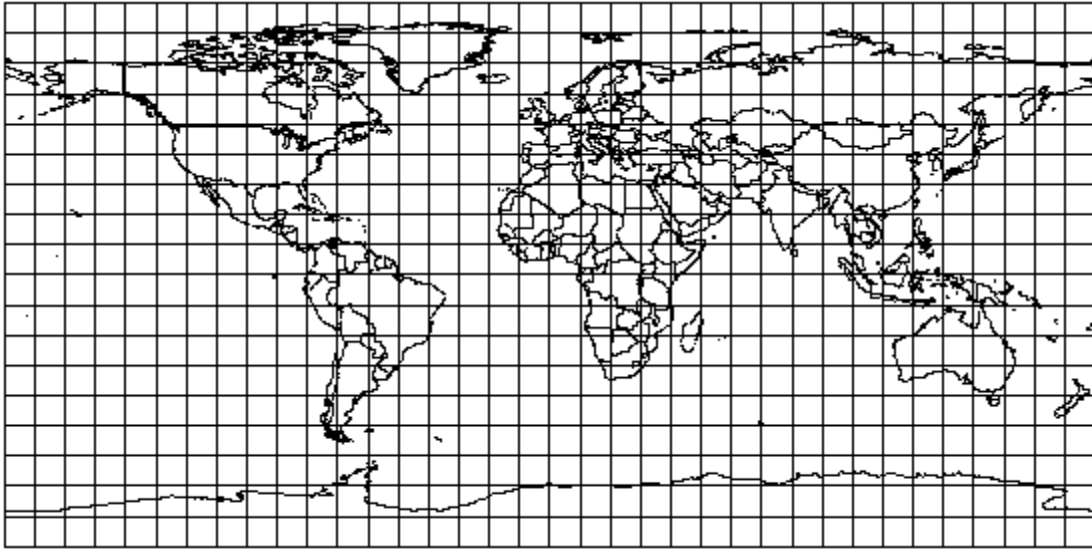

Figure A-22. Equidistant Cylindrical Projection

A.1.21 GNOMONIC PROJECTION

The Gnomonic projection is an azimuthal, perspective projection. It is neither conformal nor equal area. As shown in Figure A-23, the equator and all meridians are straight lines. For the polar aspect, meridians are equally spaced and intersect at the pole. Meridians are unequally spaced for the oblique and equatorial aspects. Except for the equator and the poles, all parallels are circles, parabolas or hyperbolas. The pole is a point on the polar aspect. On the equatorial aspect, poles can not be shown.

Scale is true only where the central line crosses the central meridian. It rapidly increases with distance from the center of the projection.

The projection is free of distortion only at the center. It rapidly increases with distance from the center of the projection.

The Gnomonic projection is used only in the spherical form.

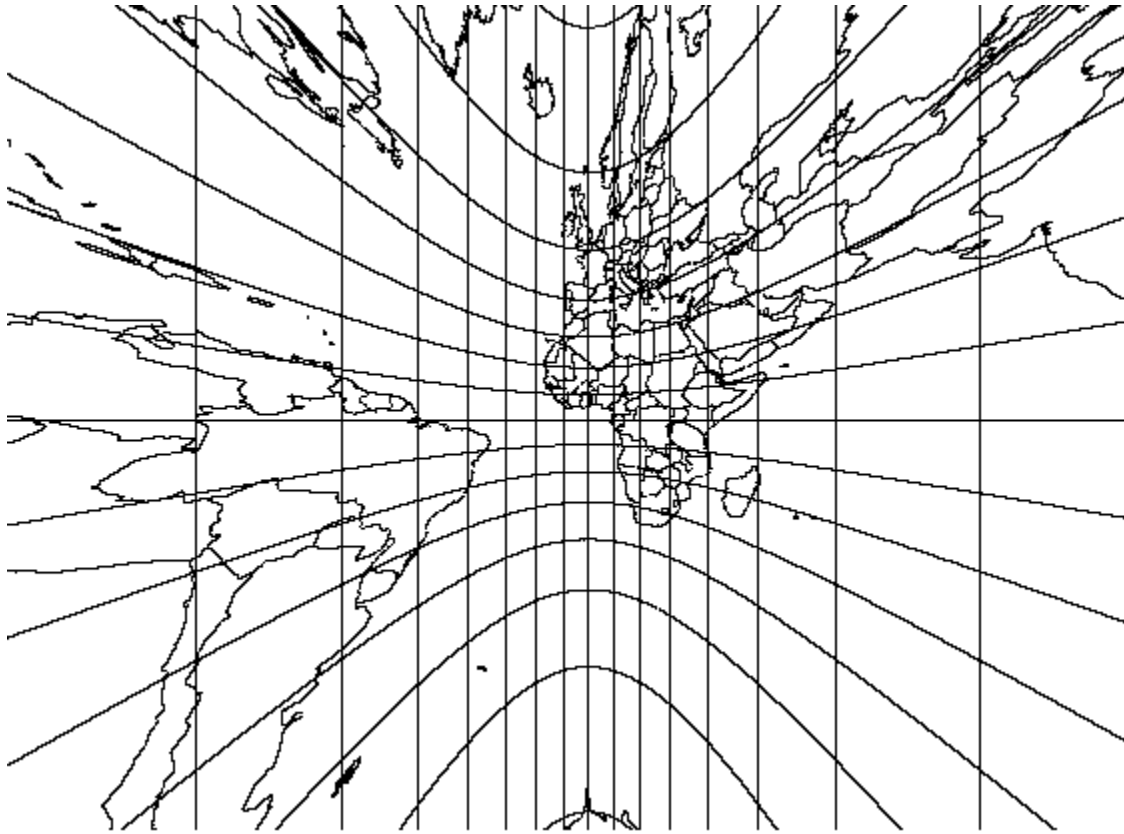

Figure A-23. Gnomonic Projection

A.1.22 LAMBERT CONFORMAL CONIC PROJECTION

The Lambert Conformal Conic projection is a conformal projection in which the projected parallels are unequally spaced arcs of concentric circles centered at the pole, as shown in Figure A-24. Spacing of parallels increases away from the origin latitude. The projected meridians are equally spaced radii of concentric circles that meet at the pole.

A Lambert Conformal Conic projection can be specified using either one or two standard parallels. In the case where there is one standard parallel, the point scale factor along that parallel is also specified. In the case where there are two standard parallels, the point scale factor is one along both of those standard parallels, and is less than one in the area between them. The point scale factor increases as a point moves outward from the standard parallel(s). The two standard parallels are generally placed at one-sixth and five-sixths of the range of latitudes to be included. When the two standard parallels are both set to the same latitude value, the result is a Lambert Conformal Conic projection with one standard parallel at the specified latitude.

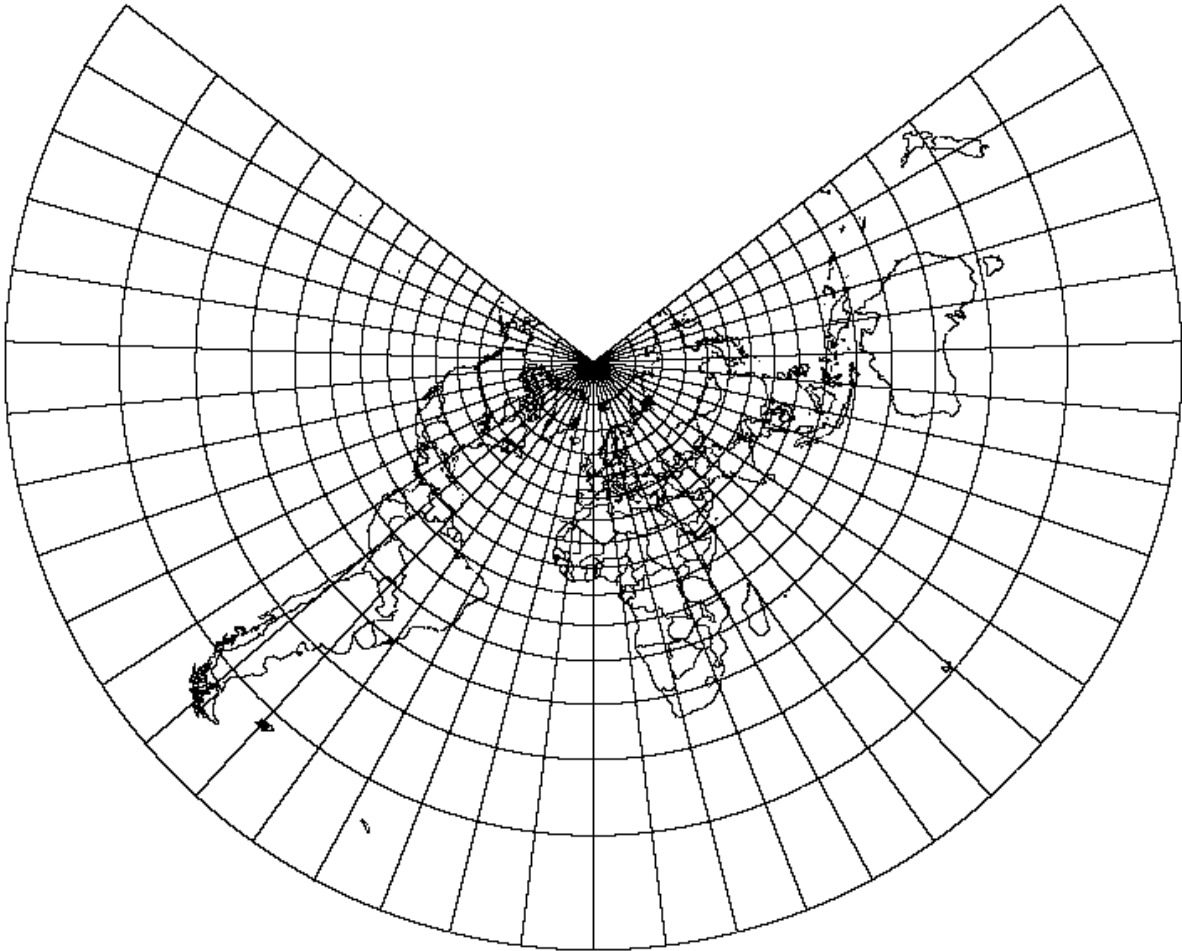

Figure A-24. Lambert Conformal Conic Projection

If there are two standard parallels that are symmetrical about the equator, the Mercator projection results. If there is only one standard parallel and it is at a pole, the Polar Stereographic projection results.

The standard parallels cannot both be 0° or the opposite sign of each other, as this would cause the cone to become a cylinder.

The pole closest to a standard parallel is a point while the other pole is at infinity. Lambert is symmetrical about any meridian

The scale is constant along any given parallel and is the same in all directions at a given point.

Lambert is free of distortion only along the standard parallel. Distortion is constant along any given parallel and conformal everywhere but at the poles.

A.1.23 MILLER CYLINDRICAL PROJECTION

The Miller Cylindrical projection is a cylindrical projection that is neither conformal nor equal area. As shown in Figure A-25, the meridians are equally spaced, straight, parallel lines 73% as long as the equator. The parallels are unequally spaced, straight lines perpendicular to the meridians. Parallel spacing increases with distance from the equator. The poles are straight lines the same length as the equator. The Miller Cylindrical projection is symmetrical about any meridian or the equator. In all directions along the equator, scale is true. At any other given latitude, scale is constant in any given direction. Latitudes of opposite sign have the same scale. Scale changes with latitude and direction.

The projection is free of distortion at the equator. Shape, area and scale distortion increase slightly away from the equator. At the poles, distortion becomes severe.

The Miller Cylindrical projection is used only in the spherical form.

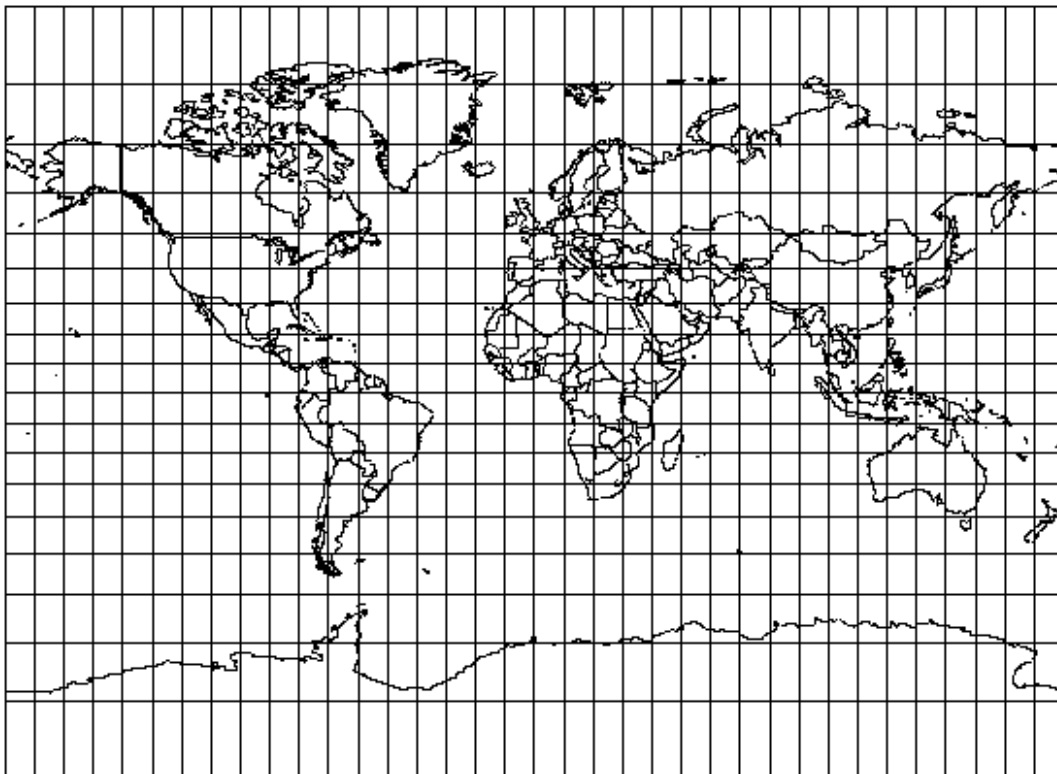

Figure A-25. Miller Cylindrical Projection

A.1.24 MOLLWEIDE PROJECTION

The Mollweide projection is a pseudocylindrical, equal area projection. As shown in Figure A-26, the central meridian is a straight line half as long as the equator. The 90° east and west meridians are circular arcs. All other meridians are equally spaced, elliptical arcs. The parallels are unequally spaced, straight, parallel lines perpendicular to the central meridian. The parallels are farthest apart near the equator. The poles are points. The Mollweide projection is symmetrical about the central meridian or the equator.

Scale is true along latitudes 40°44' N. and S. Scale is the same for latitudes of the opposite sign and is constant along any given latitude.

Distortion is severe near the outer meridians at high latitudes. The projection is free of distortion only at latitudes 40°44' N. and S. on the central meridian.

The Mollweide projection is used only in the spherical form.

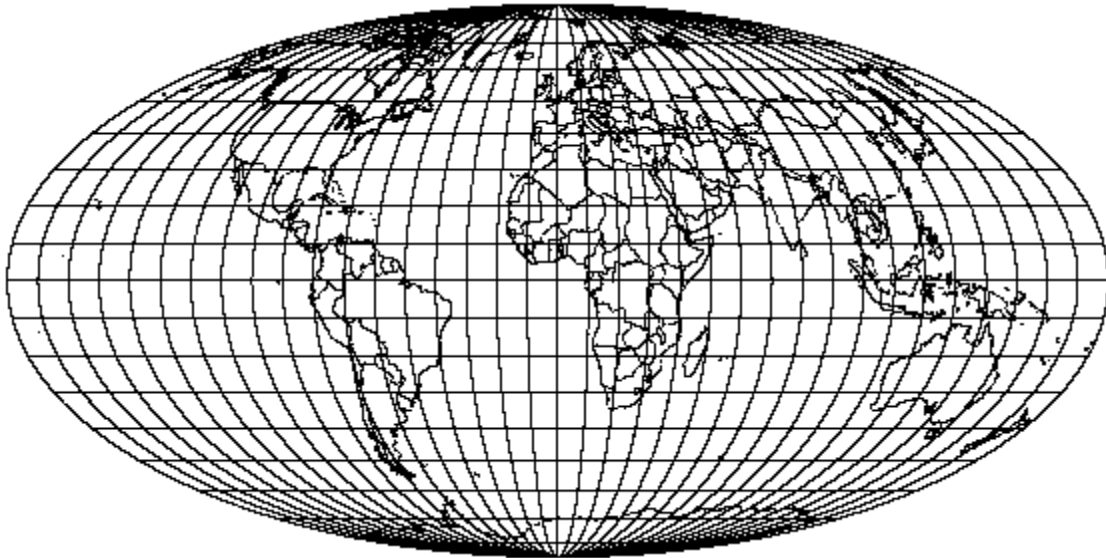

Figure A-26. Mollweide Projection

A.1.25 NEW ZEALAND MAP GRID PROJECTION

The New Zealand Map Grid projection is conformal, but otherwise is unlike any other mapping projection. The projection gives a small range of scale variation over New Zealand, which lies between 166° and 180° East longitude and 34° and 48° South latitude. Meridians and parallels are lines, as shown in Figure A-27. The central meridian, which is not straight, is oriented so that its tangent at the origin is the north-south axis of coordinates.

New Zealand Map Grid parameters are fixed at an Origin Latitude of 41°S, Central Meridian of 173°E, False Easting of 2,510,000 meters and a False Northing of 6,023,150 meters.

It uses only the International ellipsoid and the Geodetic Datum 1949 datum.

Easting values are always less than 5,000,000 meters and Northing values are always greater than 5,000,000 meters. Easting values for the land area of New Zealand range from 2,000,000 to 3,000,000 meters and Northing values range from 5,300,000 to 6,800,000 meters.



Figure A-27. New Zealand Map Grid Projection

A.1.26 NEY'S (MODIFIED LAMBERT CONFORMAL CONIC) PROJECTION

The Ney's (Modified Lambert Conformal Conic) projection is a conformal projection in which the projected parallels are expanded slightly to form complete concentric circles centered at the pole. As shown in Figure A-28, the projected meridians are radii of concentric circles that meet at the pole. Ney's is a limiting form of the Lambert Conformal Conic. There are two parallels, called standard parallels, along which the point scale factor is one. One parallel is at either ± 71 or ± 74 degrees. The other parallel is at $\pm 89\ 59\ 58.0$ degrees, depending on which hemisphere the first parallel is in.

Ney's (Modified Lambert Conformal Conic) is used near the poles. Scale distortion is small 25° to 30° from the pole. Distortion rapidly increases beyond this.

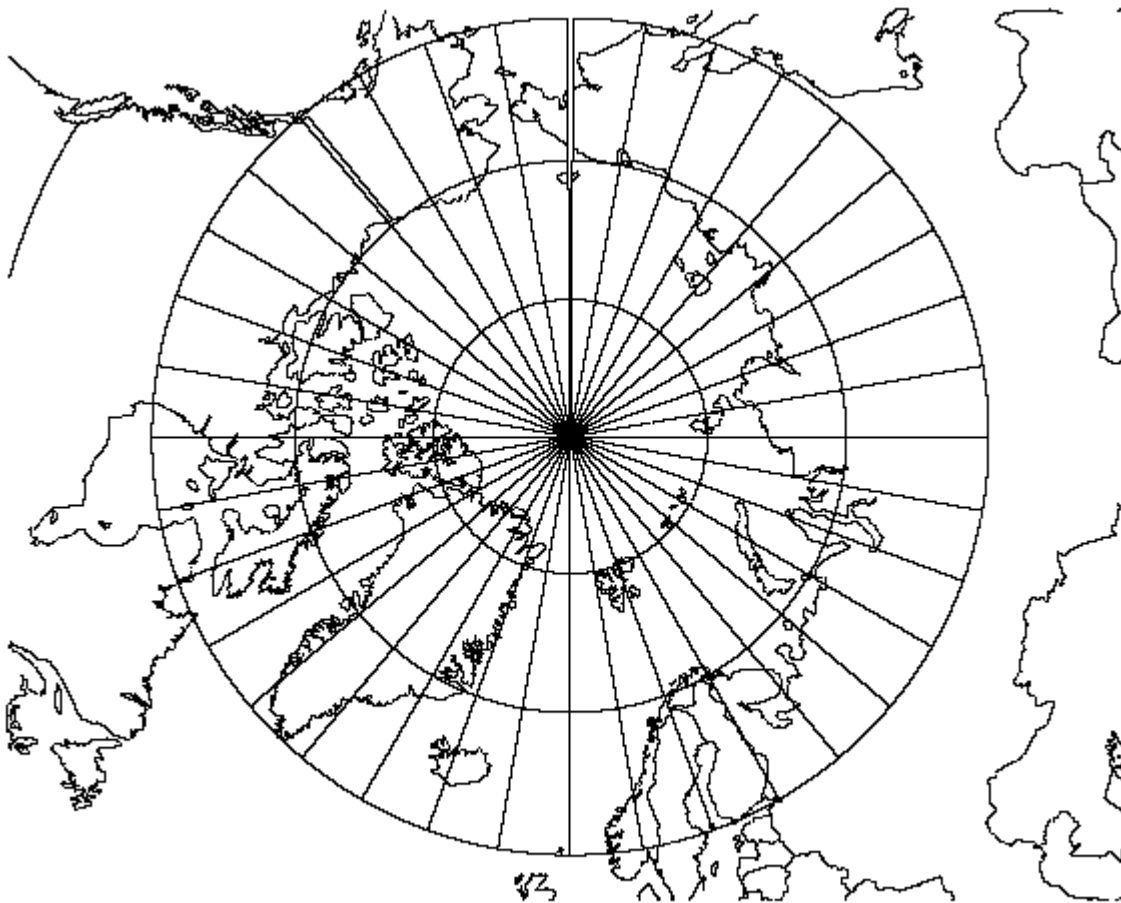

Figure A-28. Ney's (Modified Lambert Conformal Conic) Projection (Origin Latitude = 80°N , Standard Parallels = 71°N & $89\ 59\ 58.0^\circ\text{N}$)

A.1.27 OBLIQUE MERCATOR PROJECTION

The Oblique Mercator projection is an oblique, cylindrical, conformal projection. As shown in Figure A-29, there are two meridians that are straight lines 180° apart. Other meridians and parallels are complex curves. The poles are points that do not lie on the central line. The projection is symmetrical about any straight meridian.

On the spherical aspect, scale is true along the central line, a great circle at an oblique angle, or along two straight lines parallel to the central line. Scale is constant along any straight line parallel to the central line. It becomes infinite 90° from the central line. Scale on the ellipsoidal aspect is similar, but varies slightly.

Distortion is the same as that of the Mercator projection, at a given distance.

Mercator is a limiting form of Oblique Mercator with the equator as the central line. The Transverse Mercator projection is a limiting form of Oblique Mercator with a meridian as the central line.

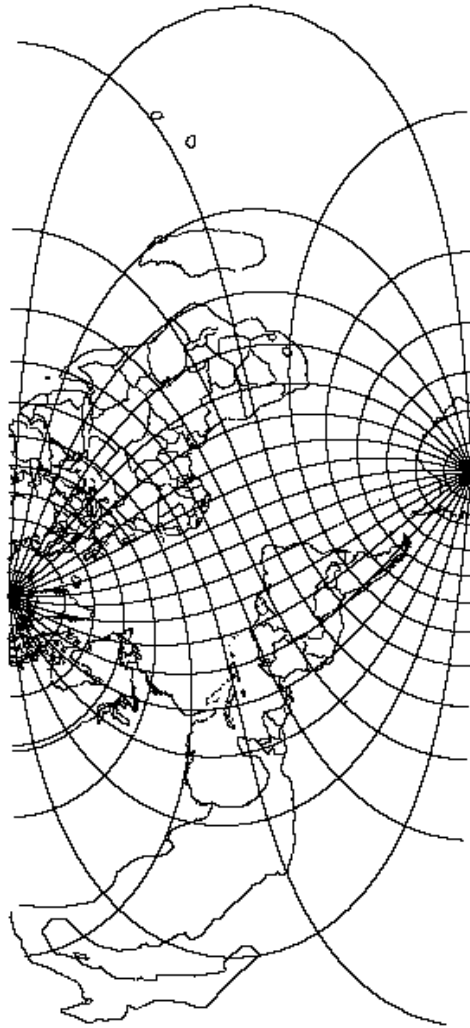

Figure A-29. Oblique Mercator Projection (Origin Latitude = 45°N, Latitude 1 = 40°N, Latitude 2 = 50°N, Longitude 1 & 2 = 0°)

A.1.28 ORTHOGRAPHIC PROJECTION

The Orthographic projection is an azimuthal, perspective projection that is neither conformal nor equal area. Only one hemisphere can be shown at a time, as shown in Figures A-30a, b, and c.

The central meridian in the equatorial aspect is a straight line. The 90° meridians form a circle representing the limit of the equatorial aspect. Other meridians are unequally spaced, ellipses of eccentricities ranging from 0 (the bounding circle) to 1.0 (the central meridian). Meridian spacing decreases away from the central meridian. Parallels are unequally spaced, straight, parallel lines perpendicular to the central meridian. Parallel spacing decreases away from the equator. Parallels intersect the outer meridian at equal intervals. The projection is symmetrical about the central meridian or equator.

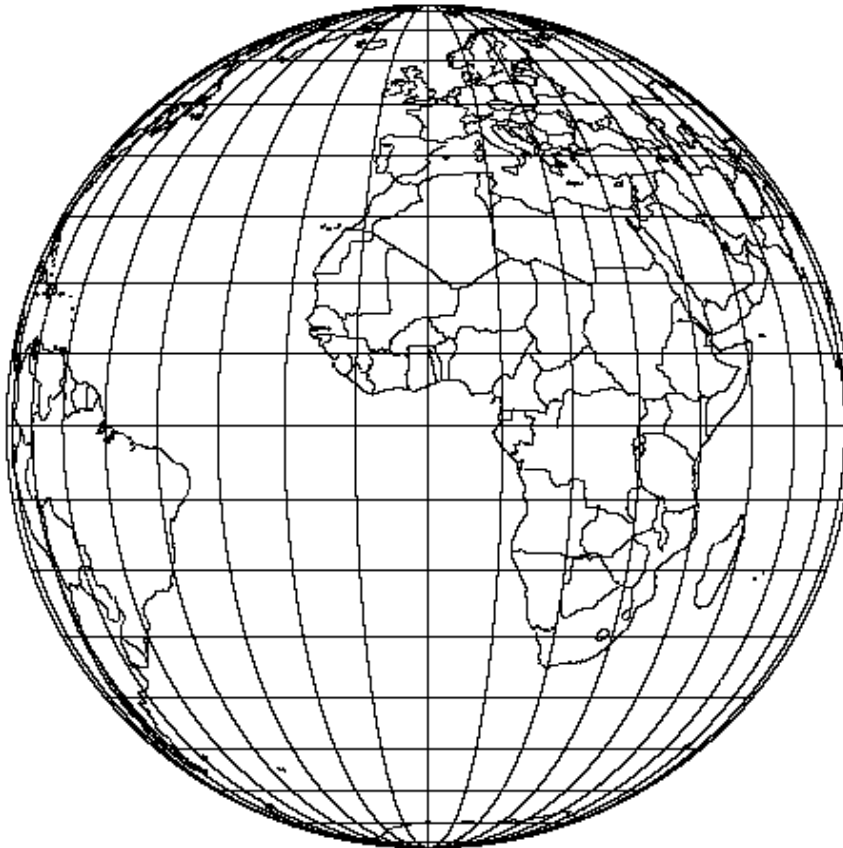

Figure A-30a. Orthographic Projection (Equatorial Aspect)

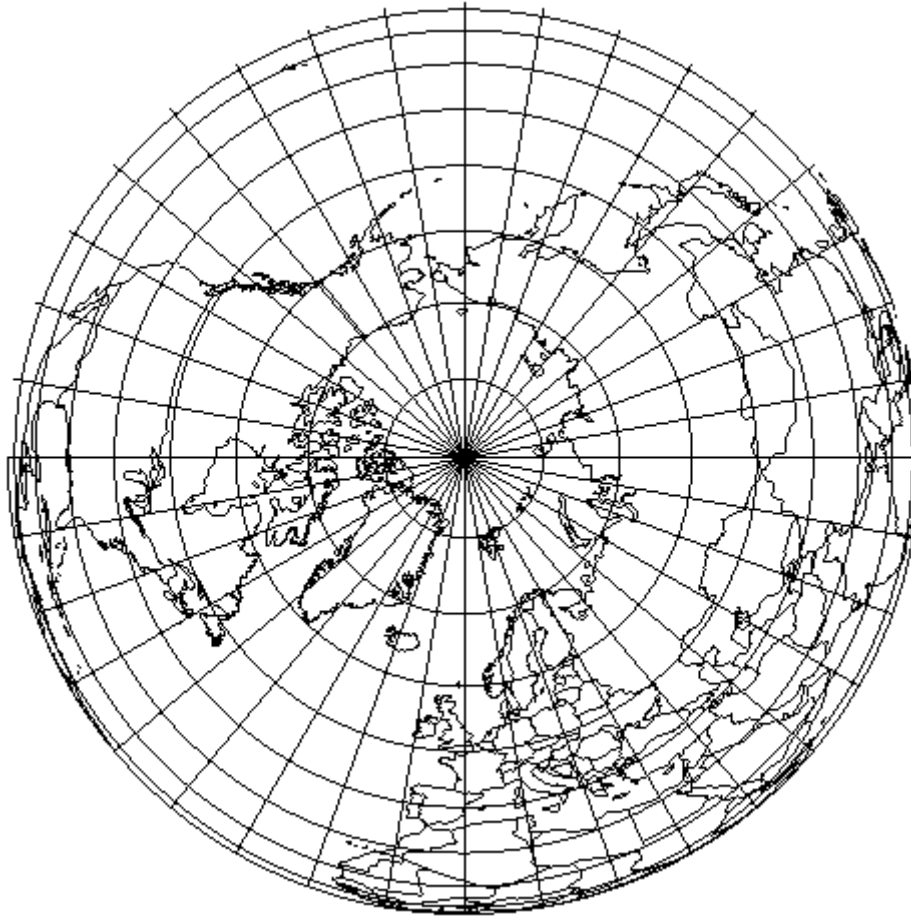

Figure A-30b. Orthographic Projection (North Polar Aspect)

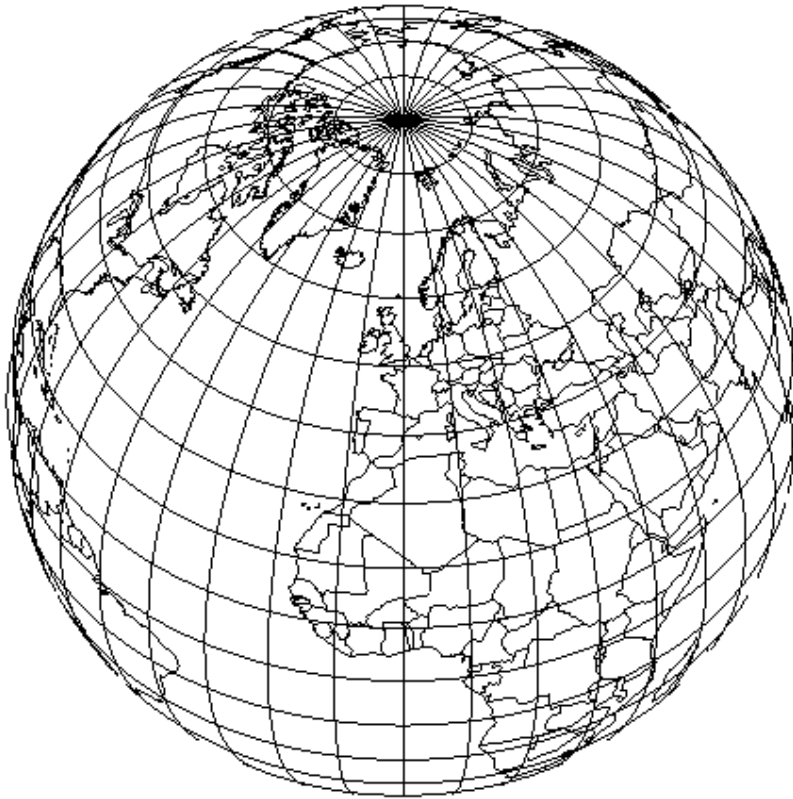

Figure A-30c. Orthographic Projection (Oblique Aspect)

For the polar aspect, meridians are equally spaced straight lines radiating from the pole at their true angles. Parallels are unequally spaced circles centered at the pole. The pole is a point. Parallel spacing decreases away from the pole. The projection is symmetrical about any meridian.

The central meridian in the oblique aspect is also a straight line. Other meridians are ellipses of varying eccentricities. Meridian spacing decreases away from the central meridian. Parallels are complete or partial ellipses with the same eccentricity, whose minor axes lie along the central meridian. Parallel spacing decreases from the center of the projection.

Scale is true at the center of the projection and along all circles drawn about the center. The scale is true only in the direction of the circumference and it decreases radially with distance from the center.

The center of the projection is free of distortion. Distortion quickly increases with distance from the center. At the outer regions, distortion is severe.

The Orthographic projection is used only in the spherical form.

A.1.29 POLYCONIC PROJECTION

The Polyconic projection is neither conformal nor equal area. As shown in Figure A-31, the central meridian is a straight line, while all other meridians are complex curves equally spaced along the equator and each parallel. The equator is a straight line, while all other parallels are non-concentric, circular arcs spaced at true intervals along the central meridian. Each parallel has a curvature developed from a cone tangent at that latitude. The poles are points. The Polyconic projection is symmetrical about the central meridian and the equator.

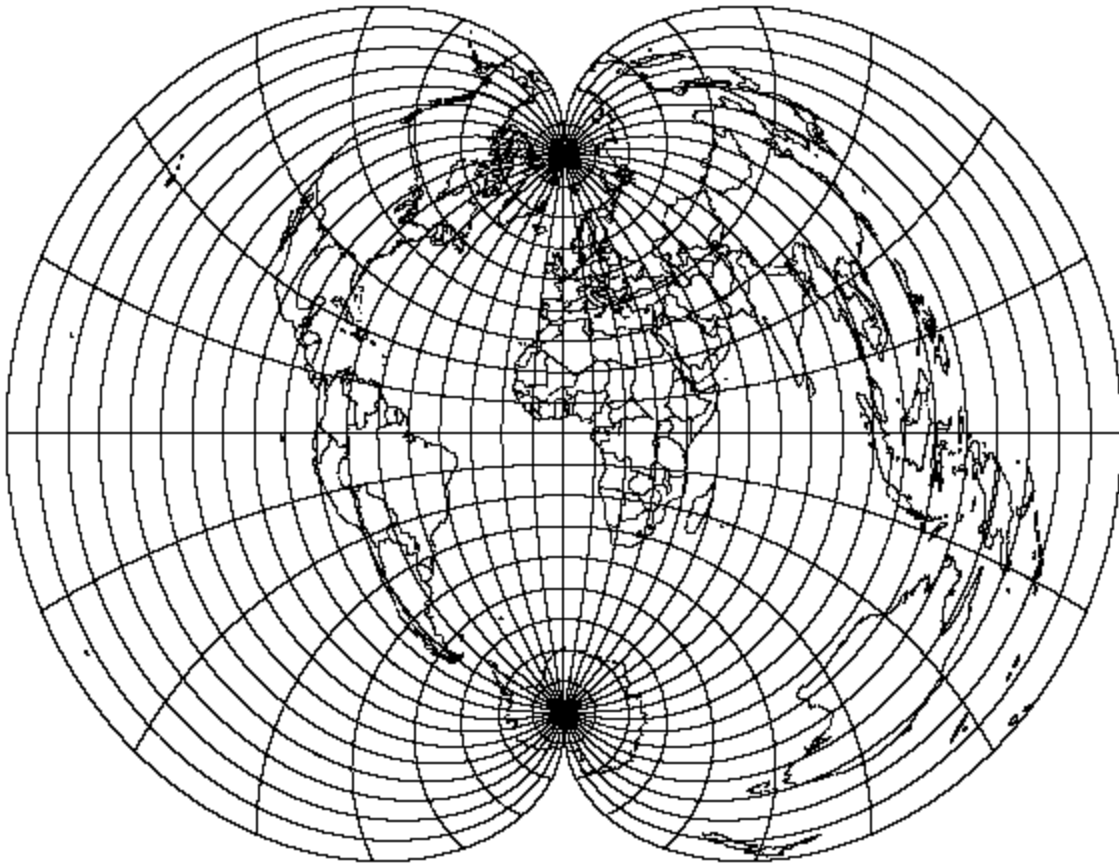

Figure A-31. Polyconic Projection

Scale is true along the central meridian and each parallel. No parallel is standard in that it has correct angles, except at the central meridian, because the meridians are lengthened by different amounts to cross each parallel at the correct position along the parallel.

The Polyconic projection is free of distortion only along the central meridian. If the range extends east or west a great distance, a large amount of distortion will result.

A.1.30 SINUSOIDAL PROJECTION

The Sinusoidal projection is a pseudocylindrical, equal area projection. As shown in Figure A-32, the central meridian is a straight line half as long as the equator. All other meridians are equally spaced sinusoidal curves that intersect at the poles. The parallels are equally spaced, straight, parallel lines perpendicular to the meridians. The poles are shown as points. The Sinusoidal projection is symmetrical about the central meridian or the equator.

Scale is true along the central meridian and every parallel.

The Sinusoidal projection is free of distortion along the central meridian and equator. At high latitudes near the outer meridians, especially in the polar regions, distortion is extreme. An interrupted form of the projection involving several central meridians helps reduce distortion.

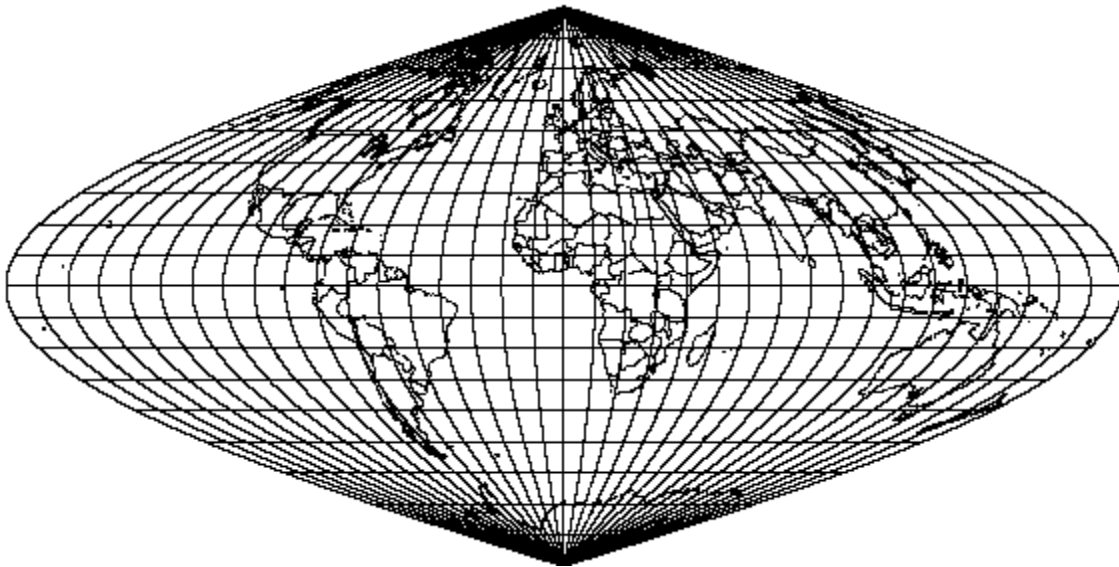

Figure A-32. Sinusoidal Projection

A.1.31 STEREOGRAPHIC PROJECTION

The Stereographic projection is an azimuthal, conformal, true perspective (for the sphere) projection in which meridians are straight lines on the polar aspect and arcs of circles on the oblique and equatorial aspects, as shown in Figure A-33. For all aspects, the central meridian is a straight line. Parallels are concentric circles, except for the equator on the equatorial aspect. It is a straight line. On the oblique aspect, the parallel opposite in sign to the origin latitude is also a straight line. For the polar aspect, the opposite pole cannot be shown.

Scale is true at the intersection of the origin latitude and central meridian. Scale is constant along any circle whose center is at the center of the projection. Scale increases away from the projection center.

The projection is free of distortion at the center.

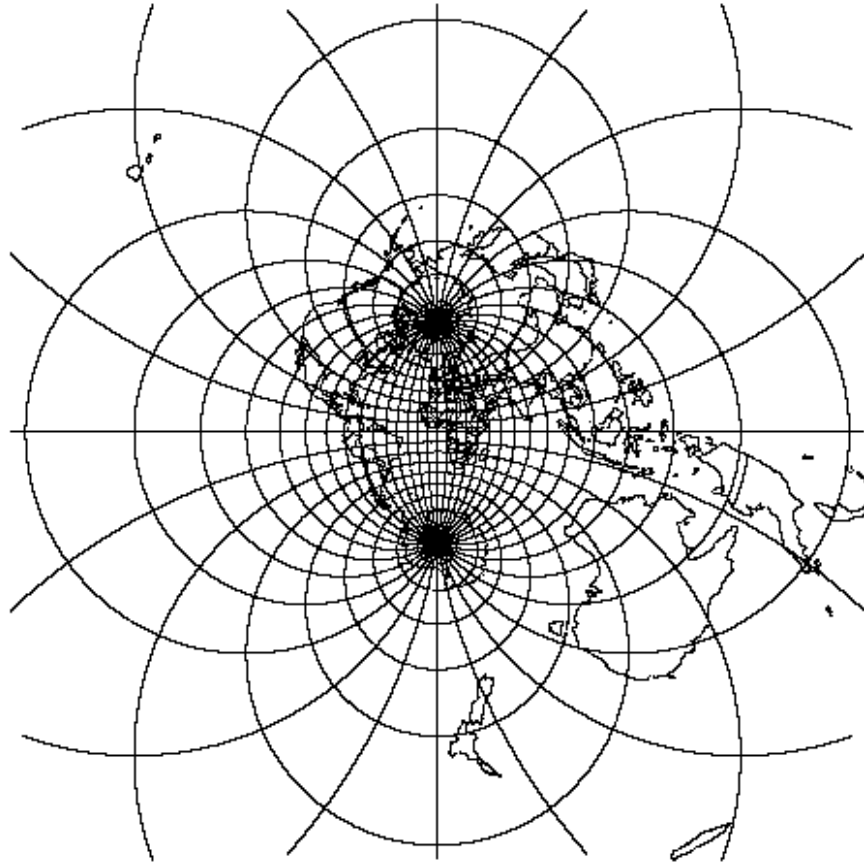

Figure A-33. Stereographic Projection

A.1.32 TRANSVERSE CYLINDRICAL EQUAL AREA PROJECTION

The Transverse Cylindrical Equal Area projection (Figure A-34) is a transverse aspect of the normal Cylindrical Equal Area projection described in section A.1.16. It is a perspective projection onto a cylinder tangent or secant at an oblique angle, or centered on a meridian. In the transverse aspect, the central meridian, each meridian 90° from the central meridian and the equator are straight lines. All other meridians and parallels are complex curves. The poles are straight lines.

Scale is true along the central meridian, or along two approximately (for the ellipsoid) straight lines equidistant from and parallel to the central meridian.

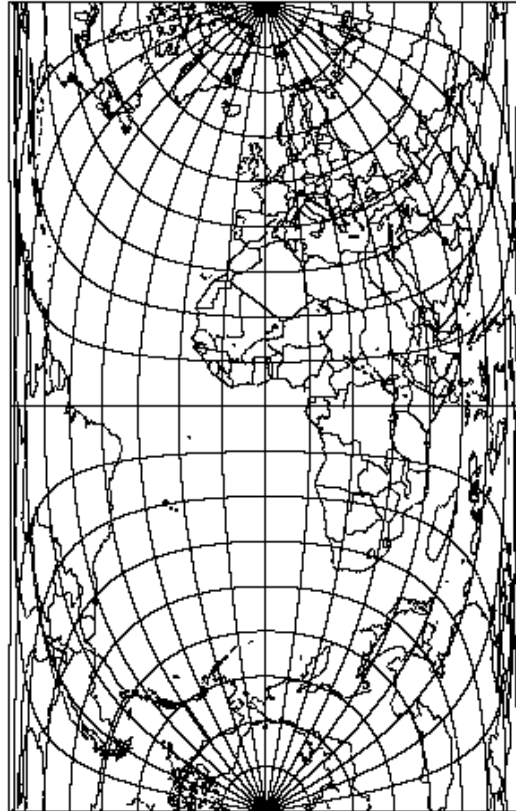

Figure A-34. Transverse Cylindrical Equal Area Projection

There is not any distortion of area. There is no scale and shape distortion at the standard parallel, but there is severe scale and shape distortion 90° from the central meridian.

A.1.33 VAN DER GRINTEN PROJECTION

The Van Der Grinten projection (Figure A-35) is neither equal area nor conformal and it is not pseudocylindrical. It shows the entire globe enclosed in a circle. The central meridian is a straight line and the other meridians are arcs of circles equally spaced along the equator. The equator is a straight line and the other parallels are arcs of circles. Parallel spacing increases with latitude. The 75th parallels are shown to be halfway between the equator and the poles. The poles are shown as points. The Van Der Grinten projection is symmetrical along the central meridian or equator.



Figure A-35. Van der Grinten Projection

Scale is true along the equator. It quickly increases with distance from the equator.

There is a large amount of area distortion near the poles.

The Van Der Grinten projection is used only in the spherical form.

A.1.34 F-16 GRID REFERENCE SYSTEM COORDINATES

The F-16 Grid Reference System (F-16 GRS) is a variant of MGRS that is intended to be compatible with the navigation system of the F-16 fighter aircraft. All other users should use standard MGRS coordinates.

At 100,000m precision, an F-16 GRS coordinate string includes two trailing zeros, following the zone number, the zone letter, and the two-letter 100,000m square designation. In a standard MGRS coordinate string, the presence of these zeros would imply 10,000m precision. However, due to a quirk in the F-16 navigation system, strings of this form are used to designate a 100,000m square. Except for this quirk, F-16 GRS coordinates are identical to MGRS coordinates.

A.2 DATUMS & ELLIPSOIDS

This section lists the ellipsoids and datums supported by GEOTRANS. Table A-1 lists the supported datums by country or geographic area, and can be used to determine which datum(s) are intended for use in a given country or geographic area. Table A-2 lists the supported ellipsoids, including their names, standard 2-letter codes, and parameter values. At startup, GEOTRANS reads this information from three files named 3_param.dat, 7_param.dat, and ellips.dat, copies of which must be located in the directory where the GEOTRANS program is being run.

Table A-1. Datums by Country/Geographic Area

Country/Geographic Area	Datum(s)
Afghanistan	Herat North
Alaska	North American 1927, 1983
Alberta	North American 1927, 1983
Antigua	Antigua Island Astro 1943, North American 1927
Argentina	Campo Inchauspe, South American 1969
Ascension Island	Ascension Island 1958
Australia	Australian Geodetic 1966, 1984
Austria	European 1950, 1979
Bahama Islands	Cape Canaveral, North American 1927
Bahrain Island	Ain el Abd 1970
Baltra, Galapagos Islands	South American 1969
Bangladesh	Indian
Barbados	North American 1927
Barbuda	North American 1927
Belgium	European 1950
Belize	North American 1927
Bolivia	Provisional South American 1956, South American 1969
Botswana	Arc 1950
Brazil	Corrego Alegre, South American 1969
British Columbia	North American 1927, 1983
Brunei	Timbalai 1948
Burkina Faso	Adindan, Point 58
Burundi	Arc 1950
Caicos Islands	North American 1927
Cameroon	Adindan, Minna
Canada	North American 1927, 1983
Canal Zone	North American 1927
Canary Islands	Pico de Las Nieves

UNCLASSIFIED

Document No. 5034289

Date: 23 October 2012

Country/Geographic Area	Datum(s)
Caribbean	North American 1927
Caroline Islands	Kusaie Astro 1951
Cayman Brac Island	L.C. 5 Astro 1961
Central America	North American 1927, 1983
Chatham Island	Chatham Island Astro 1971
Chile	Provisional South American 1956, South American 1969, PS Chile 1963
Cocos Island	Anna 1 Astro 1965
Colombia	Bogota Observatory, South American 1969
Congo	Point Noire 1948
CONUS	North American 1927, 1983
Corvo Island (Azores)	Observatorio Meteorologico 1939
Costa Rica	North American 1927
Cuba	North American 1927
Cyprus	European 1950
Denmark	European 1950
Diego Garcia	ISTS 073, Astro 1969
Djibouti	Aybella Lighthouse
Dominican Republic	North American 1927, 1983
East Canada	North American 1927, 1983
Easter Island	Easter Island 1969
Eastern United States	North American 1927, 1983
Ecuador	Provisional South American 1956, South American 1969
Eftate Island	Bellevue (IGN)
Egypt	European 1950, Old Egyptian
El Salvador	North American 1927, 1983
England	European 1950, Ordnance Survey of Great Britain
Erromango Island	Bellevue (IGN)
Eritrea	Massawa

UNCLASSIFIED

Document No. 5034289

Date: 23 October 2012

Country/Geographic Area	Datum(s)
Espirito Santo Island	Santo (DOS) 1965
Ethiopia	Adindan
Faial Island (Azores)	Graciosa Base SW 1948
Federal Republic of Germany (before 1990)	European 1950
Federal States of Micronesia	Kusaie 1951
Finland	European 1950, 1979
Flores Island (Azores)	Observatorio Meteorologico 1939
Florida	Cape Canaveral North American 1927, 1983
France	European 1950
Gabon	M'poraloko
Ghana	Leigon
Gibraltar	European 1950
Gizo Island (New Georgia Islands)	DOS 1968
Graciosa Island	Graciosa Base SW
Greece	European 1950
Greenland (Hayes Peninsula)	North American 1927
Guadalcanal Island	Gux 1 Astro
Guam	Guam 1963
Guatemala	North American 1927, 1983
Guinea-Bissau	Bissau
Guinea	Dabola
Guyana	Provisional South American 1956, South American 1969
Hawaii	Old Hawaiian, North American 1983
Honduras	North American 1927, 1983
Hong Kong	Hong Kong 1963
Iceland	Hjorsey 1955
India	Indian
Iran	European 1950

Country/Geographic Area	Datum(s)
Iraq	European 1950
Ireland	European 1950, Ireland 1965
Isle of Man	Ordnance Survey of Great Britain
Israel	European 1950
Italy	European 1950
Iwo Jima	Astro Beacon "E"
Jamaica	North American 1927
Japan	Tokyo
Johnston Island	Johnston Island 1961
Jordan	European 1950
Kalimantan Island (Indonesia)	Gunung Segara
Kauai	Old Hawaiian, North American 1983
Kenya	Arc 1960
Kerguelen Island	Kerguelen Island 1949
Korea	Tokyo
Kuwait	European 1950
Lebanon	European 1950
Leeward Islands	Fort Thomas 1955, Antigua Island Astro 1943, Montserrat Island Astro 1958
Liberia	Liberia 1964
Luxembourg	European 1950
Madagascar	Tananarive Observatory
Madeira Islands	Porto Santo 1936
Mahe Island	Mahe 1971
Malawi	Arc 1950
Malasia	Timbalai 1948
Maldives, Republic of	Gan
Mali	Adindan
Malta	European 1950
Manitoba	North American 1927, 1983

UNCLASSIFIED

Document No. 5034289

Date: 23 October 2012

Country/Geographic Area	Datum(s)
Marcus Islands	Astronomic Station 1952
Marshall Islands	Wake Eniwetok 1960
Mascarene Island	Reunion
Masirah Island (Oman)	Nahrwan
Maui	Old Hawaiian, North American 1983
Mexico	North American 1927, 1983
Micronesia	Kusaie 1951
Midway Island	Midway Astro 1961
Mindanao Island	Luzon
Montserrat	Montserrat Island Astro 1958
Morocco	Merchich
Namibia	Schwarzeck
Nepal	Indian
Netherlands	European 1950, 1979
Nevis	Fort Thomas 1955
New Brunswick	North American 1927, 1983
New Foundland	North American 1927, 1983
New Zealand	Geodetic Datum 1949
Nicaragua	North American 1927
Niger	Point 58
Nigeria	Minna
Northern Ireland	Ireland 1965
Northwest Territories	North American 1927, 1983
Norway	European 1950, 1979
Nova Scotia	North American 1927, 1983
Oahu	Old Hawaiian, North American 1983
Okinawa	Tokyo
Oman	Oman
Ontario	North American 1927, 1983

UNCLASSIFIED

Document No. 5034289

Date: 23 October 2012

Country/Geographic Area	Datum(s)
Paraguay	Chua Astro, South American 1969
Peru	Provisional South American 1956, South American 1969
Philippines	Luzon
Phoenix Islands	Canton Astro 1966
Pico Island (Azores)	Graciosa Base SW
Pitcairn Island	Pitcairn Astro 1967
Porto Santo Island	Porto Santo 1936
Portugal	European 1950
Puerto Rico	Puerto Rico
Qatar	Qatar National
Quebec	North American 1927, 1983
Salvage Islands	Selvagem Grade 1938
San Salvador Island	North American 1927
Santa Maria Islands (Azores)	Sao Braz
Sao Jorge (Azores)	Graciosa Base SW
Sao Miguel Island	Sao Braz
Sarawak and Sabah	Timbalai 1948
Sardinia	European 1950, Rome 1940
Saskatchewan	North American 1927, 1983
Saudi Arabia	Ain El Abd 1970, European 1950, Nahrwan
Scotland	European 1950, Ordnance Survey of Great Britain 1936
Senegal	Adindan
Shetland Islands	European 1950, Ordnance Survey of Great Britain 1936
Sicily	European 1950
Singapore	Kertau 1948, South Asia
Somalia	Afgooye
South Africa	Cape
South Chile	Provisional South Chilean 1963
South Georgia Islands	ISTS Astro 1968

UNCLASSIFIED

Document No. 5034289

Date: 23 October 2012

Country/Geographic Area	Datum(s)
South Greenland	Qornoq
Spain	European 1950, 1979
Sri Lanka	Kandawala
St. Helena Island	Astro Dos 71/4
St. Kitts	Fort Thomas 1955
Sudan	Adindan
Sumatra Island (Indonesia)	Djakarta (Botavia)
Surinam	Zanderij
Swaziland	Arc 1950
Sweden	European 1950, 1979
Switzerland	European 1950, 1979
Syria	European 1950, 1979
Taiwan	Hu-Tzu-Shan
Tanzania	Arc 1960
Tasmania Asland	Australian Geodetic 1966, 1984
Terceira Islands (Azores)	Graciosa Base SW
Tern Island	Astro/Tern Island (Frig) 1961
Thailand	Indian
Trinidad and Tobago	Naparima, BWI; South American 1969
Tristan da Cunha	Tristan Astro
Tunisia	Carthage
Turks and Caicos Islands	North American 1927
United Arab Emirates	Nahrwan
Uruguay	Yacare
Venezuela	Provisional South American 1956, South American 1969
Vietnam	Indian
Virgin Islands	Puerto Rico
Viti Levu Island (Fiji Island)	Indian
Wales	Ordnance Survey of Great Britain 1936

Document No. 5034289

Date: 23 October 2012

Country/Geographic Area	Datum(s)
Wake Atoll	Wake Island Astro 1952
Western Europe	European 1950
West Malaysia	Kertau 1948
Western United States	North American 1927, 1983
Yukon	North American 1927, 1983
Zaire	Arc 1950
Zimbabwe	Arc 1950

Table A-2. Reference Ellipsoids and their Parameters

Reference Ellipsoid	ID Code	Semi-Major Axis a	Semi-Minor Axis b	Inverse Flattening f
Airy (1930)	AA	6377563.396000000	6356256.909237285	299.3249646000000
Australian National	AN	6378160.000000000	6356774.719195306	298.2500000000000
Bessel 1841				
Ethiopia, Indonesia, Japan, Korea	BR	6377397.155000000	6356078.962818188	299.1528128000000
Namibia	BN	6377483.865000000	6356165.382966325	299.1528128000000
Clarke 1866	CC	6378206.400000000	6356583.800000000	294.9786982139058
Clarke 1880	CD	6378249.145000000	6356514.869549776	293.4650000000000
Everest				
Brunei & E. Malaysia (Sabah & Sarawak)	EB	6377298.556000000	6356097.550300897	300.8017000000000
India 1830	EA	6377276.345000000	6356075.413140240	300.8017000000000
India 1956*	EC	6377301.243000000	6356100.228368101	300.8017000000000
Pakistan*	EF	6377309.613000000	6356108.570542461	300.8017000000000
W. Malaysia and Singapore 1948	EE	6377304.063000000	6356103.038993154	300.8017000000000
W. Malaysia 1969*	ED	6377295.664000000	6356094.667915204	300.8017000000000
Geodetic Reference System 1980 (GRS 80)	RF	6378137.000000000	6356752.314140356	298.2572221010000
Helmert 1906	HE	6378200.000000000	6356818.169627891	298.3000000000000
Hough 1960	HO	6378270.000000000	6356794.343434343	297.0000000000000
Indonesian 1974	ID	6378160.000000000	6356774.504085540	298.2470000000000
International 1924	IN	6378388.000000000	6356911.946127946	297.0000000000000
Krassovsky 1940	KA	6378245.000000000	6356863.018773047	298.3000000000000
Modified Airy	AM	6377340.189000000	6356034.447938534	299.3249646000000
Modified Fischer 1960 (South Asia)	FA	6378155.000000000	6356773.320482736	298.3000000000000

Document No. 5034289

Date: 23 October 2012

South American 1969	SA	6378160.000000000	6356774.719195306	298.2500000000000
World Geodetic System 1972 (WGS 72)	WD	6378135.000000000	6356750.520016093	298.2600000000000
World Geodetic System 1984 (WGS 84)	WE	6378137.000000000	6356752.314245179	298.2572235630000

Note: Semi-major and semi-minor axis values are in meters, while inverse flattening values are unitless. Values that end in multiple zeroes are defined (or measured) values, while other values are derived through calculation. With the exception of the CC ellipsoid, semi-minor axis values are calculated from the semi-major axis and inverse flattening values.

* Through adoption of a new yard to meter conversion factor in the referenced country.

APPENDIX B – ACRONYMS

API	Application Programming Interface
CCS	Coordinate Conversion Service
CD-ROM	Compact Disk – Read Only Memory
CSAT	Coordinate Systems Analysis Team
DR	Discrepancy Report
DVD	Digital Versatile/Video Disk
EGM	Earth Gravity Model
ER	Enhancement Request
GCC	Gnu Compiler Collection
GEOTRANS	Geographic Translator
GUI	Graphical User Interface
JRE	Java Runtime Environment
MB	MegaByte
MS	Microsoft
MSL	Mean Sea Level
MSP	Mensuration Services Program
NGA	National Geospatial-Intelligence Agency
RHEL	Red Hat Enterprise Linux
WWW	World Wide Web